

PRODUCT CATALOG 2026

Modules, Nozzles, Guns, Hoses, Rebuild Kits



PACKAGING PARTS



GLENMAR TECHNOLOGY

U.S.-Manufactured Replacement Parts for the Nonwoven Industry

At Glenmar Technology, we specialize in manufacturing high-quality, cost-effective replacement parts for hot melt adhesive systems used in nonwoven and packaging applications. Whether you're running Nordson® or ITW Dynatec® equipment, our direct replacement parts are built to deliver the same performance, at a fraction of the cost.

For over two decades, factories across North America, Latin America, and Europe have relied on Glenmar to reduce operating costs without compromising reliability or uptime. From nozzles and modules to filters and applicators, our parts are engineered and assembled in the USA, using top-grade materials that meet or exceed OEM standards.

Nonwoven manufacturers trust Glenmar for high-quality replacement parts that deliver up to 50% savings compared to OEMs. Trusted by leaders like Kimberly-Clark, Domtar & Ontex, our parts are backed by fast shipping, reliable inventory, and strong support.

MODULES



Replacement for Nordson SolidBlue S

Air-open, Spring-closed module design delivering precise adhesive control while withstanding continuous production cycles with minimal maintenance.

NORDSON	GLENMAR	DESCRIPTION	PRICE
1052925	GM-52925	SolidBlue S H200 Module - G100 Blue AO/SC	\$135.00
272282	GM-72282	ClassicBlue H200 Module - G100 Blue AO/SC	\$135.00
276119	GM-76119	ClassicBlue H200 Module - G100 Blue AO/SC	\$135.00
1048115	GM-48115	ClassicBlue H200 Module - G100 Blue AO/SC	\$135.00

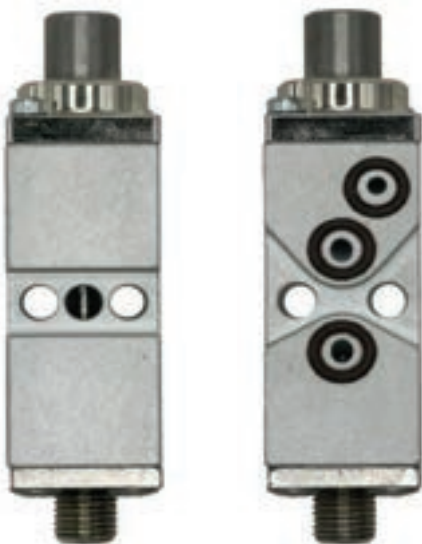

Replacement for Nordson SolidBlue A

Air-open, Air-closed module design delivering precise adhesive control while withstanding continuous production cycles with minimal maintenance.

NORDSON	GLENMAR	DESCRIPTION	PRICE
1052927	GM-52927	Solidblue A H200 Module - G100 Blue AO/AC	\$150.00
1054951	GM-54951	Blank Module with Cutout SolidBlue/SureBead	\$120.00

MODULES



Replacement for Nordson ClassicBlue Slot Modules

Designed for precise adhesive dispensing. Engineered for industrial environments, this module integrates seamlessly with Nordson ClassicBlue systems.

NORDSON	GLENMAR	DESCRIPTION	PRICE
1051718	GM-51718	ClassicBlue Slot Module 0.38" – G100S	\$330.00
1051719	GM-51719	ClassicBlue Slot Module 0.50" – G100S	\$330.00
1051720	GM-51720	ClassicBlue Slot Module 0.75" – G100S	\$330.00
1051721	GM-51721	ClassicBlue Slot Module 2.00" – G100S	\$330.00



Replacement for Nordson Zero Cavity AO/AC

Air-open, Air-closed module design delivering precise adhesive control while withstanding continuous production cycles with minimal maintenance.

NORDSON	GLENMAR	DESCRIPTION	PRICE
1051703	GM-51703	400 Series Replacement Module – G100ZAA	\$460.00

MODULES



Replacement for Nordson® ClassicBlue ZE

Designed for precise adhesive dispensing. Engineered for industrial environments, this module integrates seamlessly with Nordson ClassicBlue systems.

NORDSON	GLENMAR	DESCRIPTION	PRICE
1054376	GM-54376	ClassicBlue ZE Replacement 0.012 – G100ZA-EX	\$785.00
1051736	GM-51736	ClassicBlue ZE Replacement 0.020 – G100ZA-EX	\$785.00
1051737	GM-51737	ClassicBlue ZE Replacement 0.032 – G100ZA-EX	\$785.00
1051738	GM-51738	ClassicBlue ZE Replacement 0.040 – G100ZA-EX	\$785.00



Replacement for Nordson Zero Cavity

Designed for seamless compatibility with Nordson Hot Melt Systems.

Nozzle Sizes from 0.012" to 0.032"

NORDSON	GLENMAR	DESCRIPTION	PRICE
276516	GM-76516	Zero Cavity Module 0.012"	\$460.00
276517	GM-76517	Zero Cavity Module 0.016"	\$460.00
276518	GM-76518	Zero Cavity Module 0.020"	\$460.00
276519	GM-76519	Zero Cavity Module 0.032"	\$460.00

MODULES



Replacement for Nordson [Zero Cavity](#)
w/ Needle Adjustment

Designed for seamless compatibility with Nordson Hot Melt Systems.

Nozzle Sizes from 0.010" to 0.040"

NORDSON	GLENMAR	DESCRIPTION	PRICE
1051704	GM-51704	Zero Cavity Module w/ Needle Adjustment 0.010"	\$425.00
1051741	GM-51741	Zero Cavity Module w/ Needle Adjustment 0.012"	\$425.00
1054379	GM-54379	Zero Cavity Module w/ Needle Adjustment 0.012"	\$425.00
1051742	GM-51742	Zero Cavity Module w/ Needle Adjustment 0.016"	\$425.00
1051743	GM-51743	Zero Cavity Module w/ Needle Adjustment 0.020"	\$425.00
1051744	GM-51744	Zero Cavity Module w/ Needle Adjustment 0.032"	\$425.00
1051745	GM-51745	Zero Cavity Module w/ Needle Adjustment 0.040"	\$425.00



CONTACT US NOW!

+1 908-561-9920
info@glenmartech.com - glenn.kiesel@gmail.com
1233 North Ave, Plainfield, NJ 07062, USA



MODULES



Replacement for Nordson H2O Modules

This module integrates seamlessly into H2O systems, supporting high-performance adhesive dispensing.

NORDSON	GLENMAR	DESCRIPTION	PRICE
153011	GM-53011	H2O Module - G10 Module	\$210.00
272549	GM-72549	H2O Module Large Ball and Seat - G10 Module	\$285.00



Replacement for Nordson MiniBlue II, Ball and Seat Modules

MiniBlue II hot melt applicators provide the longest service life of any pneumatic gun in the packaging industry.

You will reduce maintenance, downtime and replacement parts costs with MiniBlue II applicators.

NORDSON	GLENMAR	DESCRIPTION	PRICE
1095703	GM-95703	MiniBlue II BAS Module - G300 Mini Standard	\$220.00
1099966	GM-99966	MiniBlue II BAS Module - G300 Mini Standard	\$220.00
1120093	GM-20093	MiniBlue II Blank Module - G300 Mini Standard	\$120.00

MODULES



Replacement for Nordson MiniBlue II, Mini Zero Modules

MiniBlue II hot melt applicators provide the longest service life of any pneumatic gun in the packaging industry.

With our replacement modules you will reduce maintenance, downtime and replacement parts costs for your MiniBlue II applicators.

NORDSON	GLENMAR	DESCRIPTION	PRICE
1072928	GM-72928	MiniBlue II Module – G300 Mini Zero 0.008"	\$280.00
1121479	GM-21479	MiniBlue II Module – G300 Mini Zero 0.008"	\$280.00
1099967	GM-99967	MiniBlue II Module – G300 Mini Zero 0.008"	\$280.00
1073060	GM-73060	MiniBlue II Module – G300 Mini Zero 0.012"	\$280.00
1121480	GM-21480	MiniBlue II Module – G300 Mini Zero 0.012"	\$280.00
1099969	GM-99969	MiniBlue II Module – G300 Mini Zero 0.012"	\$280.00
1073062	GM-73062	MiniBlue II Module – G300 Mini Zero 0.016"	\$280.00
1121481	GM-21481	MiniBlue II Module – G300 Mini Zero 0.016"	\$280.00
1099970	GM-99970	MiniBlue II Module – G300 Mini Zero 0.016"	\$280.00
1073064	GM-73064	MiniBlue II Module – G300 Mini Zero 0.020"	\$280.00
1121482	GM-21482	MiniBlue II Module – G300 Mini Zero 0.020"	\$280.00
1099971	GM-99971	MiniBlue II Module – G300 Mini Zero 0.020"	\$280.00
1121483	GM-21483	MiniBlue II Module – G300 Mini Zero 0.032"	\$280.00
1099972	GM-99972	MiniBlue II Module – G300 Mini Zero 0.032"	\$280.00
1121484	GM-21484	MiniBlue II Module – G300 Mini Zero 0.040"	\$280.00
1099973	GM-99973	MiniBlue II Module – G300 Mini Zero 0.040"	\$280.00

MODULES

G100 Module

\$135.00



G100S Module

\$330.00



G100Z - NA Module

\$460.00



G100ZA Module

\$425.00



G100F Module

\$330.00



G100F-PAD Module

\$330.00



G100AA Module

\$150.00



G100FAA Module

\$330.00

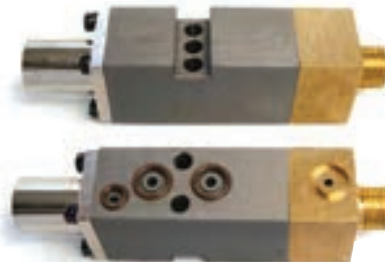

G100ZAA Module

\$460.00



At Glenmar Technology
We offer all module types for easy installation

FLAT BACK ← → BUTTERFLY CUT

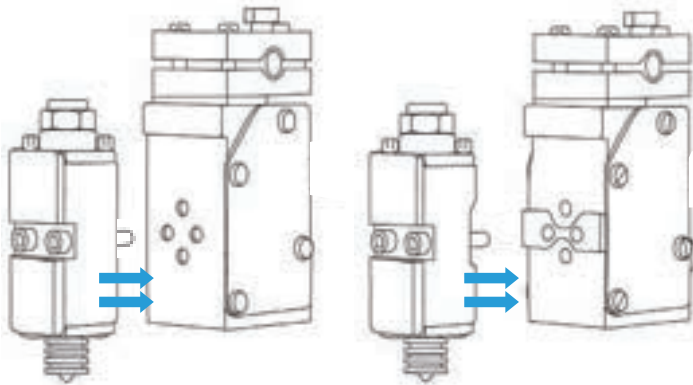

SPARE PARTS

At Glenmar Technology you will find
High-quality Replacement parts
at a fraction of the OEM Price



G100-001
Nut
\$0.90



G100-008
Piston Seal
\$1.00



G100-015
Seal Spring Loaded
\$7.70



G100-002
Adjusting Screw
\$1.55



G100-009
Needle w/ Carbide Ball
\$20.90



G100-016
Washer
\$0.35



G100-003
Spring 3/8 x 1 1/8
\$1.10



G100-0010
Star Lock Washer
\$0.35



G100-017
Spring 27/64 x 33/64
\$1.10



G100-004
Screw 6-32 x 5/8
\$0.65



G100-011
Hat Seal
\$0.75



G100-018
O-Ring
\$0.35



G100-005
End Cap Adjusting
\$2.65



G100-012
Piston Seal
\$0.35



G100-019
Seal Spring Loaded
\$20.90



G100-006
Screw 4-40 x 1/8
\$0.65



G100-013
Module Body
\$26.40



G100-020
Screw 8-32
\$0.65



G100-007
Washer
\$0.45



G100-014
Mounting Screws
\$0.45

G100 Module

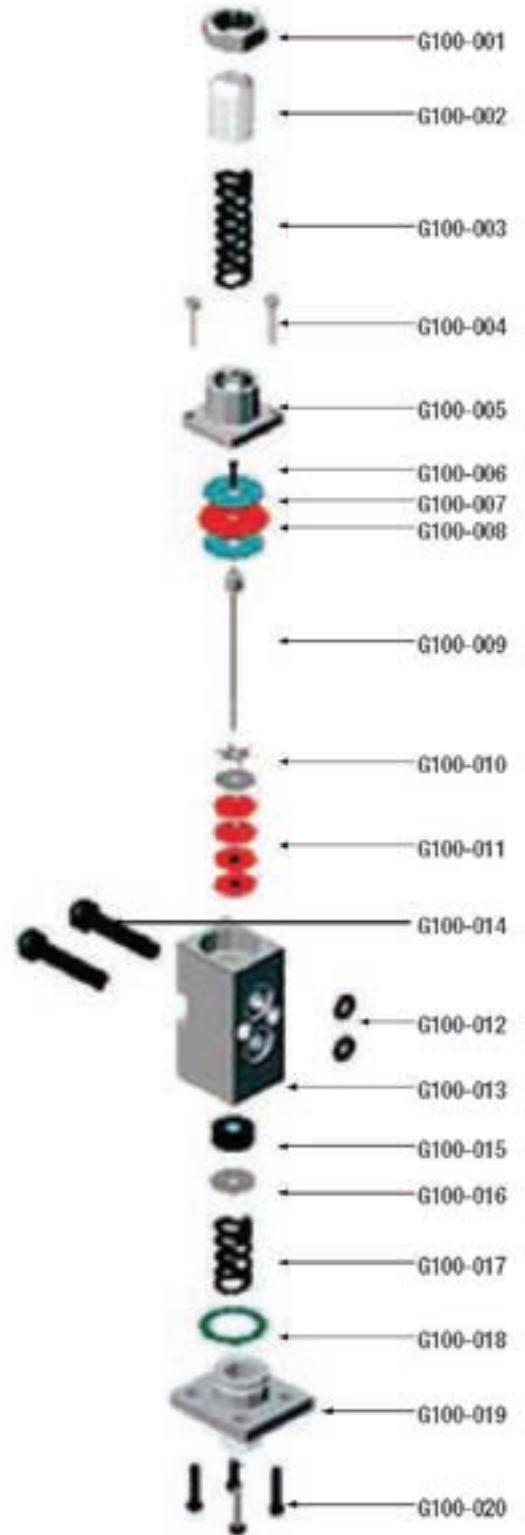
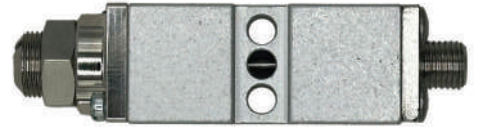

G100Z Module

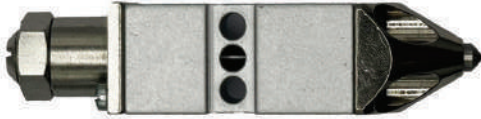

SPARE PARTS

*Glenmar is more than a parts supplier.
We're your partner in productivity and high performance.*

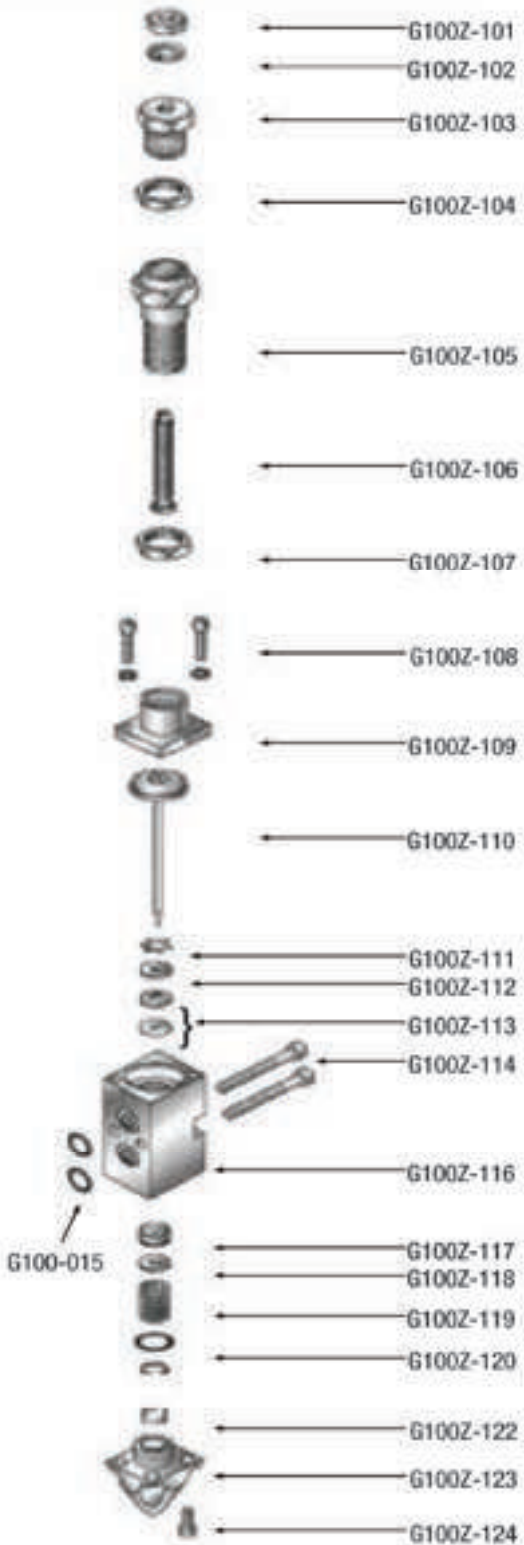

G100Z-101
\$0.25



G100Z-109
\$6.60



G100Z-117
\$7.90



G100Z-102
\$0.25



G100Z-110
\$39.60



G100Z-118
\$0.35



G100Z-103
\$11.00



G100Z-111
\$0.35



G100Z-119
\$1.10



G100Z-104
\$6.60



G100Z-112
\$0.35



G100Z-120
\$0.35



G100Z-105
\$15.40



G100Z-113
\$0.75



G100Z-121
\$5.30



G100Z-106
\$13.20



G100Z-114
\$0.35



G100Z-123
\$132.00



G100Z-107
\$6.60



G100Z-115
\$0.35



G100Z-124
\$0.35



G100Z-108
\$0.65



G100Z-116
\$26.40

SPARE PARTS

Each product is tested to meet demanding standards in Nonwoven, Hygiene, and Packaging applications.



G100F-001
Nut
\$0.90



G100F-008
Piston Seal
\$1.00



G100F-015
Seal Spring Loaded
\$7.70



G100F-002
Adjusting Screw
\$2.45



G100F-008
Needle w/ Carbide Ball
\$20.90



G100F-015
Washer
\$0.35



G100F-003
Spring 3/8 x 1 1/8
\$1.10



G100F-008
Star Lock Washer
\$0.35



G100F-017
Spring 27/64 x 33/64
\$1.10



G100F-004
Screw 6-32 x 5/8
\$0.65



G100F-011
Hat Seal
\$0.75



G100F-018
O-Ring
\$0.35



G100F-005
End Cap Adjusting
\$2.65



G100F-012
O-Ring (2X)
\$0.35



G100F-019
Seat w/ Insert
\$92.40



G100F-006
Screw 4-40 x 1/8
\$0.65



G100F-013
Module Body
\$26.40



G100F-020
Screw 8-32 (4x)
\$0.65



G100F-007
Washer (2x)
\$0.45



G100F-014
Mounting Screw
\$0.45

G100F Module

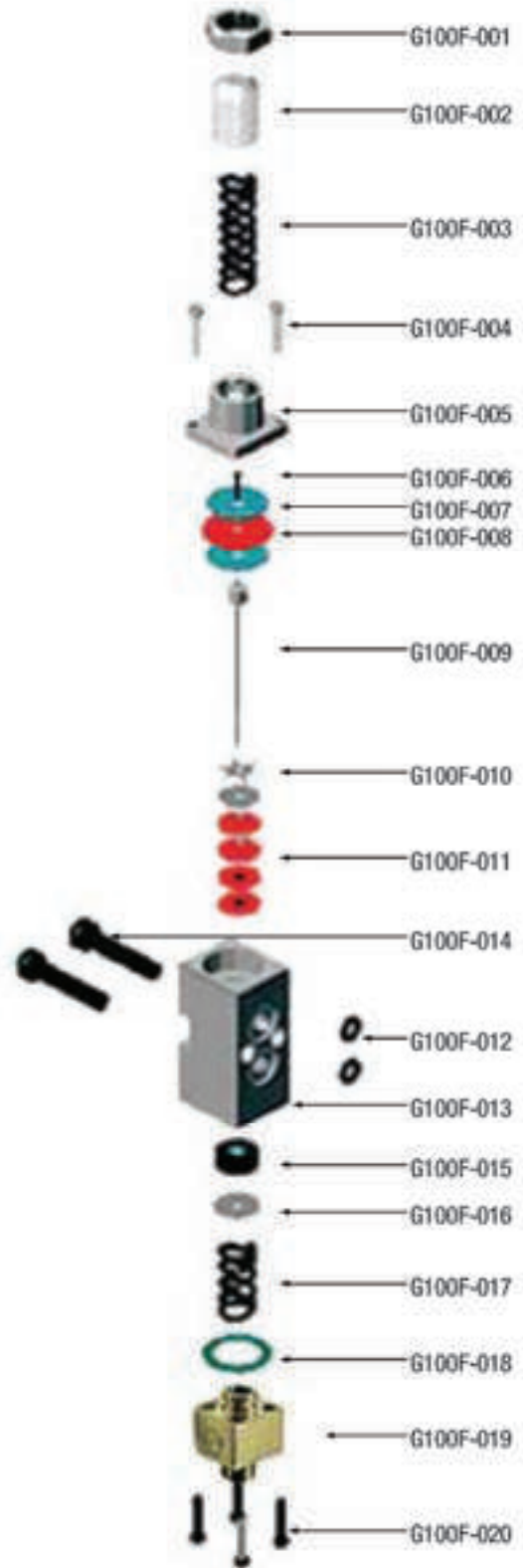

G10 Module

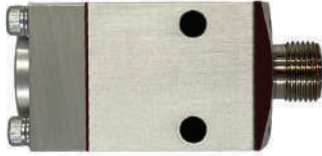

SPARE PARTS

Most orders ship within 24-48 hours helping you stay on schedule and avoid expensive interruptions.

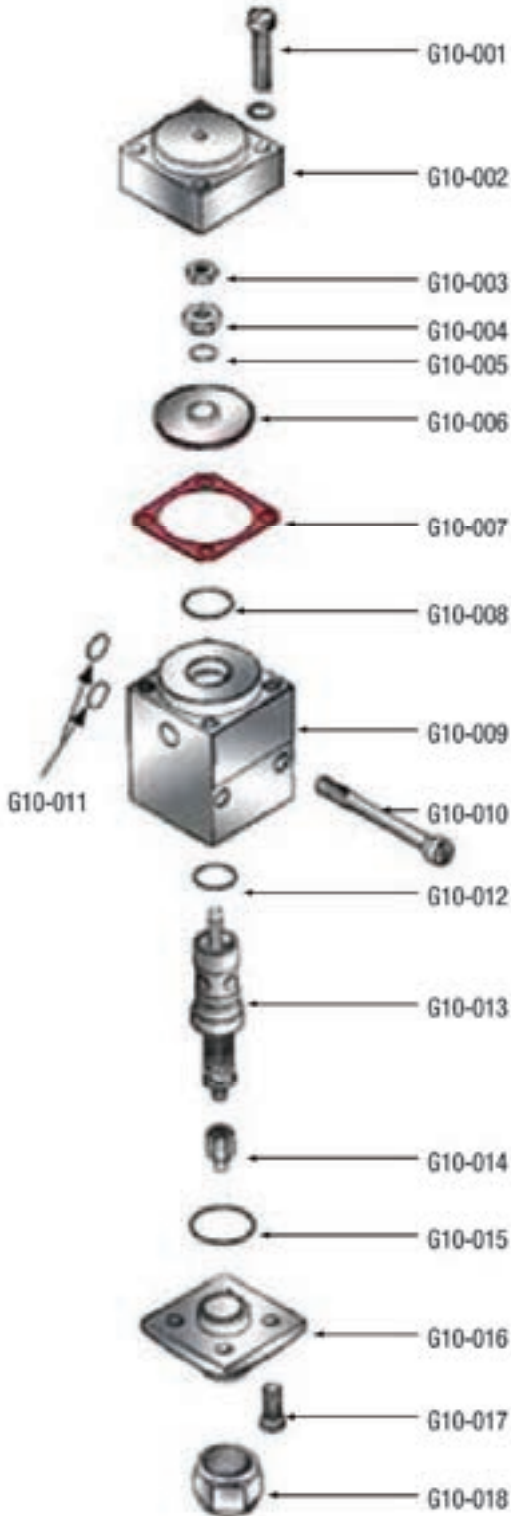

G10-001
Screw, Fil Hd w/ Washer
\$0.75



G10-002
End Cap
\$1.55



G10-003
Upper Nut Lock (10-32)
\$1.30



G10-004
Locknut Seal
\$2.65



G10-005
O-Ring Viton
\$0.55



G100-006
Screw 4-40 x 1/8
\$5.30



G10-006-1 \$1.30



G10-006-2 \$0.65



G10-006-3 \$2.00



G10-006-4 \$0.65



G10-007
Gasket (Gun G10 Glue Gun)
\$5.30



G10-008
O-ring Viton
\$0.75



G10-009
Module Body
\$92.40



G10-010
Module Body Screw
\$0.75



G10-011
O-Ring Viton
\$0.75



G10-012
O-Ring Viton
\$0.75



G100-013
Complete Needle Assembly
\$52.80



G10-013-2 \$13.20



G10-013-3 \$1.55



G10-013-4 \$4.00



G10-014
Ball & Seat Assembly
\$6.60



G10-015
O-Ring Viton
\$0.75



G10-016
Seat
\$39.60



G10-018
Oval Screw (10-32 x 0.5)
\$0.65



G10-018
Retaining Nut
\$2.10

SPARE PARTS



G300.MINISTD Module
Takes Glenmar GNS Nozzles



G300.MINI Module

NOZZLES SIZE OPTION

- G300.MINI.012
- G300.MINI.014
- G300.MINI.016
- G300.MINI.018
- G300.MINI.020
- G300.MINI.024
- G300.MINI.035

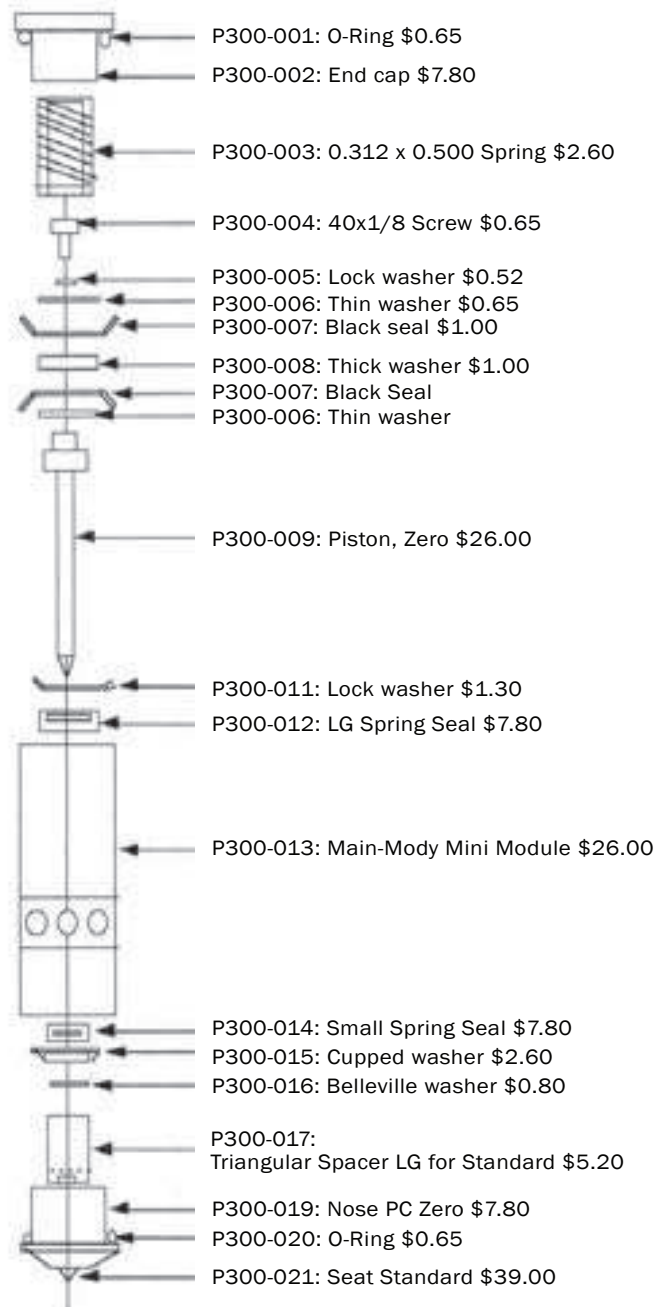
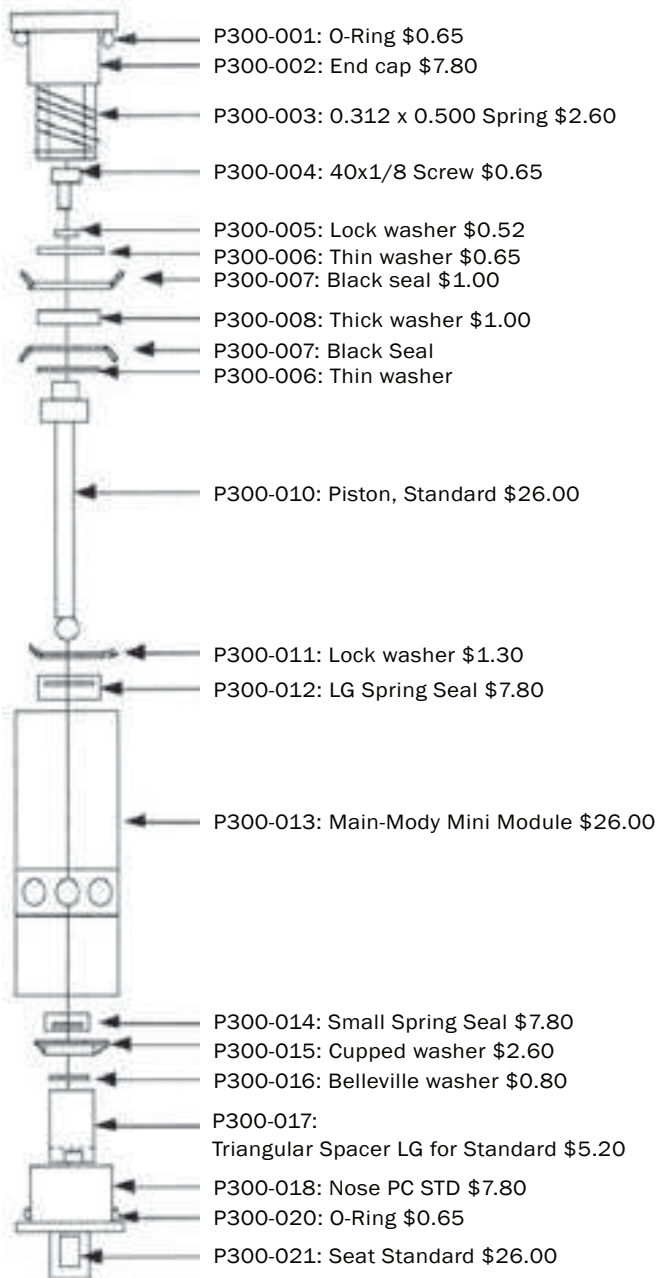

NOZZLES



Replacement for Nordson Right-Angle Single Bead Nozzle 90°

Precision nozzles provide superior pattern placement to maximize product quality and reduce rejects. Flow accuracy and consistency increase control and reduce adhesive use.

NORDSON	GLENMAR	DESCRIPTION	PRICE
320012	GM-20012	Right-Angle Single Bead Nozzle -0.012" GNR 90°	\$23.50
238739	GM-38739	Right-Angle Single Bead Nozzle -0.012" GNR 90°	\$23.50
244518	GM-44518	Right-Angle Single Bead Nozzle -0.012" GNR 90°	\$23.50
1011012	GM-11012	Right-Angle Single Bead Nozzle -0.012" GNR 90°	\$23.50
244519	GM-44519	Right-Angle Single Bead Nozzle -0.014" GNR 90°	\$23.50
320014	GM-20014	Right-Angle Single Bead Nozzle -0.014" GNR 90°	\$23.50
1011014	GM-11014	Right-Angle Single Bead Nozzle -0.014" GNR 90°	\$23.50
244520	GM-44520	Right-Angle Single Bead Nozzle -0.016" GNR 90°	\$23.50
320016	GM-20016	Right-Angle Single Bead Nozzle -0.016" GNR 90°	\$23.50
1011016	GM-11016	Right-Angle Single Bead Nozzle -0.016" GNR 90°	\$23.50
130114	GM-30114	Right-Angle Single Bead Nozzle -0.018" GNR 90°	\$23.50
320018	GM-20018	Right-Angle Single Bead Nozzle -0.018" GNR 90°	\$23.50
1011018	GM-11018	Right-Angle Single Bead Nozzle -0.018" GNR 90°	\$23.50
238743	GM-38743	Right-Angle Single Bead Nozzle -0.020" GNR 90°	\$23.50
270853	GM-70853	Right-Angle Single Bead Nozzle -0.020" GNR 90°	\$23.50
320020	GM-20020	Right-Angle Single Bead Nozzle -0.020" GNR 90°	\$23.50
1011020	GM-11020	Right-Angle Single Bead Nozzle -0.020" GNR 90°	\$23.50

NOZZLES

NORDSON	GLENMAR	DESCRIPTION	PRICE
165782	GM-65782	Right-Angle Single Bead Nozzle -0.030" GNR 90°	\$23.50
320030	GM-20030	Right-Angle Single Bead Nozzle -0.030" GNR 90°	\$23.50
320040	GM-20040	Right-Angle Single Bead Nozzle -0.040" GNR 90°	\$23.50
804832	GM-04832	Right-Angle Single Bead Nozzle -0.040" GNR 90°	\$23.50
1011040	GM-11040	Right-Angle Single Bead Nozzle -0.040" GNR 90°	\$23.50



Replacement for Nordson Right-Angle Dual Bead Nozzle 90-15°

Precision nozzles provide superior pattern placement to maximize product quality and reduce rejects. Flow accuracy and consistency increase control and reduce adhesive use.

NORDSON	GLENMAR	DESCRIPTION	PRICE
165776	GM-65776	Right-Angle Dual Bead Nozzle -0.012" GNR 90-15°	\$52.00
320112	GM-20112	Right-Angle Dual Bead Nozzle -0.012" GNR 90-15°	\$52.00
1015812	GM-15812	Right-Angle Dual Bead Nozzle -0.012" GNR 90-15°	\$52.00
273384	GM-73384	Right-Angle Dual Bead Nozzle -0.014" GNR 90-15°	\$46.00
320114	GM-20114	Right-Angle Dual Bead Nozzle -0.014" GNR 90-15°	\$46.00
1015814	GM-15814	Right-Angle Dual Bead Nozzle -0.014" GNR 90-15°	\$46.00
320116	GM-20116	Right-Angle Dual Bead Nozzle -0.016" GNR 90-15°	\$46.00
804047	GM-04047	Right-Angle Dual Bead Nozzle -0.016" GNR 90-15°	\$46.00
1015816	GM-15816	Right-Angle Dual Bead Nozzle -0.016" GNR 90-15°	\$46.00
165777	GM-65777	Right-Angle Dual Bead Nozzle -0.018" GNR 90-15°	\$46.00
320118	GM-20118	Right-Angle Dual Bead Nozzle -0.018" GNR 90-15°	\$46.00

NOZZLES

NORDSON	GLENMAR	DESCRIPTION	PRICE
1015818	GM-15818	Right-Angle Dual Bead Nozzle -0.018" GNR 90-15°	\$46.00
271938	GM-71938	Right-Angle Dual Bead Nozzle -0.020" GNR 90-15°	\$46.00
320120	GM-20120	Right-Angle Dual Bead Nozzle -0.020" GNR 90-15°	\$46.00
1015820	GM-15820	Right-Angle Dual Bead Nozzle -0.020" GNR 90-15°	\$46.00



Replacement for Nordson Right-Angle Dual Bead Nozzle 90-30°

Precision nozzles provide superior pattern placement to maximize product quality and reduce rejects. Flow accuracy and consistency increase control and reduce adhesive use.

NORDSON	GLENMAR	DESCRIPTION	PRICE
270698	GM-70698	Right-Angle Dual Bead Nozzle -0.012" GNR 90-30°	\$46.00
320212	GM-20212	Right-Angle Dual Bead Nozzle -0.012" GNR 90-30°	\$46.00
1015912	GM-15912	Right-Angle Dual Bead Nozzle -0.012" GNR 90-30°	\$46.00
270699	GM-70699	Right-Angle Dual Bead Nozzle -0.014" GNR 90-30°	\$46.00
320214	GM-20214	Right-Angle Dual Bead Nozzle -0.014" GNR 90-30°	\$46.00
1015914	GM-15914	Right-Angle Dual Bead Nozzle -0.014" GNR 90-30°	\$46.00
270700	GM-70700	Right-Angle Dual Bead Nozzle -0.016" GNR 90-30°	\$46.00
320216	GM-20216	Right-Angle Dual Bead Nozzle -0.016" GNR 90-30°	\$46.00
101596	GM-01596	Right-Angle Dual Bead Nozzle -0.016" GNR 90-30°	\$46.00
165780	GM-65780	Right-Angle Dual Bead Nozzle -0.018" GNR 90-30°	\$46.00
320218	GM-20218	Right-Angle Dual Bead Nozzle -0.018" GNR 90-30°	\$46.00
1015918	GM-15918	Right-Angle Dual Bead Nozzle -0.018" GNR 90-30°	\$46.00

NOZZLES

NORDSON	GLENMAR	DESCRIPTION	PRICE
320220	GM-20220	Right-Angle Dual Bead Nozzle -0.018" GNR 90-30°	\$46.00
709786	GM-09786	Right-Angle Dual Bead Nozzle -0.020" GNR 90-30°	\$46.00
1015920	GM-15920	Right-Angle Dual Bead Nozzle -0.020" GNR 90-30°	\$46.00



Replacement for Nordson Single-Orifice (Bead) Straight Nozzles

Precision nozzles provide superior pattern placement to maximize product quality and reduce rejects. Flow accuracy and consistency increase control and reduce adhesive use.

NORDSON	GLENMAR	DESCRIPTION	PRICE
322010	GM-22010	Single-Orifice (Bead) Straight Nozzles 0.010" GNS	\$23.50
322110	GM-22110	Single-Orifice (Bead) Straight Nozzles 0.010" GNS	\$23.50
322012	GM-22012	Single-Orifice (Bead) Straight Nozzles 0.012" GNS	\$23.50
322112	GM-22112	Single-Orifice (Bead) Straight Nozzles 0.012" GNS	\$23.50
322212	GM-22212	Single-Orifice (Bead) Straight Nozzles 0.012" GNS	\$23.50
322312	GM-22312	Single-Orifice (Bead) Straight Nozzles 0.012" GNS	\$23.50
322014	GM-22014	Single-Orifice (Bead) Straight Nozzles 0.014" GNS	\$23.50
322114	GM-22114	Single-Orifice (Bead) Straight Nozzles 0.014" GNS	\$21.00
322214	GM-22214	Single-Orifice (Bead) Straight Nozzles 0.014" GNS	\$21.00
322314	GM-22314	Single-Orifice (Bead) Straight Nozzles 0.014" GNS	\$21.00
322016	GM-22016	Single-Orifice (Bead) Straight Nozzles 0.016" GNS	\$21.00
322116	GM-22116	Single-Orifice (Bead) Straight Nozzles 0.016" GNS	\$21.00
322216	GM-22216	Single-Orifice (Bead) Straight Nozzles 0.016" GNS	\$21.00
322316	GM-22316	Single-Orifice (Bead) Straight Nozzles 0.016" GNS	\$21.00

NOZZLES

NORDSON	GLENMAR	DESCRIPTION	PRICE
322018	GM-322018	Single-Orifice (Bead) Straight Nozzles 0.018" GNS	\$21.00
322118	GM-22118	Single-Orifice (Bead) Straight Nozzles 0.018" GNS	\$21.00
322218	GM-22218	Single-Orifice (Bead) Straight Nozzles 0.018"GNS	\$21.00
322318	GM-22318	Single-Orifice (Bead) Straight Nozzles 0.018"GNS	\$21.00
322020	GM-22020	Single-Orifice (Bead) Straight Nozzles 0.020" GNS	\$21.00
322320	GM-22320	Single-Orifice (Bead) Straight Nozzles 0.020" GNS	\$21.00
322024	GM-22024	Single-Orifice (Bead) Straight Nozzles 0.024"GNS	\$21.00
322124	GM-22124	Single-Orifice (Bead) Straight Nozzles 0.024" GNS	\$21.00
322224	GM-22224	Single-Orifice (Bead) Straight Nozzles 0.024"GNS	\$21.00
322324	GM-22324	Single-Orifice (Bead) Straight Nozzles 0.024"GNS	\$21.00
1058927	GM-58927	Single-Orifice (Bead) Straight Nozzles 0.028"	\$21.00



Replacement for Nordson Single-Orifice (Bead) Straight Nozzles

Precision nozzles provide superior pattern placement to maximize product quality and reduce rejects. Flow accuracy and consistency increase control and reduce adhesive use.

NORDSON	GLENMAR	DESCRIPTION	PRICE
322412	GM-22412	Single-Orifice (Bead) Straight Nozzles 0.012" GNS300	\$21.00
322414	GM-22414	Single-Orifice (Bead) Straight Nozzles 0.014" GNS300	\$21.00
322416	GM-22416	Single-Orifice (Bead) Straight Nozzles 0.016" GNS300	\$21.00
322418	GM-22418	Single-Orifice (Bead) Straight Nozzles 0.018" GNS300	\$21.00
322421	GM-22421	Single-Orifice (Bead) Straight Nozzles 0.021" GNS300	\$21.00
322424	GM-22424	Single-Orifice (Bead) Straight Nozzles 0.024" GNS300	\$21.00
322428	GM-22428	Single-Orifice (Bead) Straight Nozzles 0.028" GNS300	\$21.00

APPLICATORS

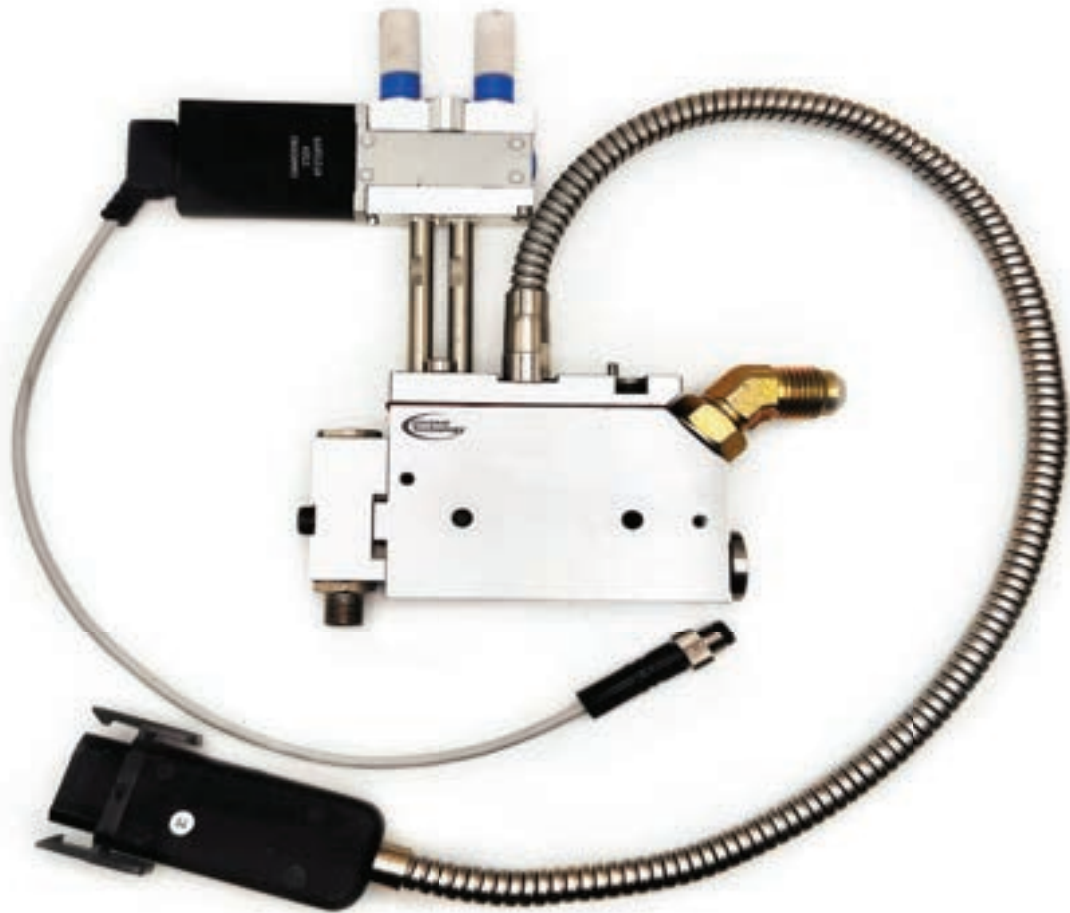

Replacement for Nordson MiniBlue II Applicator

Glenmar's replacement for Nordson® MiniBlue II applicator delivers high-speed, precise adhesive dispensing for demanding packaging applications. Built for durability and minimal maintenance, it supports cycle rates up to 8,000 per minute and ensures consistent, clean adhesive application.

NORDSON	GLENMAR	DESCRIPTION	PRICE
8527491	GM-527491	MiniBlue II Hotmelt Applicator	\$1,250.00
8517894	GM-517894	MiniBlue II Hotmelt Applicator	\$1,250.00
8517895	GM-517895	MiniBlue II Hotmelt Applicator	\$1,250.00
8517901	GM-517901	MiniBlue II Hotmelt Applicator	\$1,250.00
8533354	GM-33354	MiniBlue II Hotmelt Applicator	\$1,250.00
1131020	GM-31020	MiniBlue II Hotmelt Applicator	\$1,250.00

APPLICATORS



Replacement for Nordson Single Module H201 Applicators - Glenmar G100 Applicators

Compatible with 2300/3000, ProBlue and DuraBlue melters, this single applicator delivers precise and consistent hot melt dispensing. Offered in various spacing options, with standard, washdown, common, or independent air configurations available.

*Need a custom applicator?
Let Glenmar design a solution tailored to your specific application.*

NORDSON	GLENMAR	DESCRIPTION	
224939	GM-24939	HEAD, H201T 240V RTD.	Quote
274596	GM-74596	HEAD, H201T 240V RTD.	Quote
8503591	GM-03591	HEAD, H201T 240V RTD.	Quote
8503686	GM-03686	HEAD, H201T 240V RTD.	Quote
276777	GM-76777	HEAD, H201T 240V RTD.	Quote
725737	GM-25737	HEAD, H201T 240V RTD.	Quote
8503640	GM-03640	HEAD, H201T 240V RTD.	Quote
8504074	GM-04074	HEAD, H201T 240V RTD.	Quote
809195	GM-09195	HEAD, H201T ZC12 240V RTD	Quote
8503623	GM-03623	HEAD, H201T ZC12 240V RTD	Quote
809196	GM-09196	HEAD, H201T ZC16 240V RTD	Quote
8503624	GM-03624	HEAD, H201T ZC16 240V RTD	Quote
809197	GM-09197	HEAD, H201T ZC20 240V RTD	Quote

APPLICATORS

NORDSON	GLENMAR	DESCRIPTION	
103613	GM-03613	HEAD, H201T ZC12 240V RTD	Quote
109616	GM-09616	HEAD, H201T ZC12 240V RTD	Quote
8503627	GM-03627	HEAD, H201T ZC12 240V RTD	Quote
815139	GM-03627	HEAD, H201T 240V RTD. W/ FILTER	Quote



Replacement for Nordson Dual Module H202 Applicators - Glenmar G202 Applicators

Compatible with 2300/3000, ProBlue and DuraBlue melters, this dual applicator delivers precise and consistent hot melt dispensing. Offered in various spacing options, with standard, washdown, common, or independent air configurations available.

Need a custom applicator? Let Glenmar design a solution tailored to your specific application.

NORDSON	GLENMAR	DESCRIPTION	
651650	GM-51650	HEAD, H202T 240V RTD. SWIVEL	Quote
731997	GM-31997	HEAD, H202T 240V RTD. SWIVEL	Quote
731999	GM-31999	HEAD, H202T 240V RTD. SWIVEL	Quote
731967	GM-31967	HEAD, H202T 240V RTD 0.88 CTRS CA	Quote
809467	GM-09467	HEAD, H202T 240V RTD 0.88 CTRS CA	Quote
1063584	GM-63584	HEAD, H202T 240V RTD 0.88 CTRS CA	Quote
1501864	GM-01864	HEAD, H202T 240V RTD 0.88 CTRS CA	Quote
8504842	GM-04842	HEAD, H202T 240V RTD 0.88 CTRS CA	Quote
8504849	GM-04842	HEAD, H202T 240V RTD 0.88 CTRS CA	Quote

APPLICATORS

NORDSON	GLENMAR	DESCRIPTION	
8506418	GM-06418	HEAD, H202T 240V RTD 0.88 CTRS CA	Quote
809686	GM-09619	HEAD, H202T 240V RTD 0.80 CTRS IA	Quote
8504848	GM-05257	HEAD, H202T 240V RTD 0.80 CTRS IA	Quote
809619	GM-09619	HEAD, H202T 240V RTD 1.00 CTRS CA	Quote
8505257	GM-05257	HEAD, H202T 240V RTD 1.00 CTRS CA	Quote
8513013	GM-13013	HEAD, H202T 240V RTD 1.00 CTRS CA	Quote
809558	GM-09558	HEAD, H202T 240V RTD 1.00 CTRS CA	Quote
715463	GM-15463	HEAD, H202T 240V RTD 1.00 CTRS IA	Quote
150627	GM-50627	HEAD, H202T 240V RTD 1.50 CTRS IA	Quote
8404841	GM-04841	HEAD, H202T 240V RTD 1.50 CTRS CA	Quote
8504843	GM-04843	HEAD, H202T 240V RTD 1.50 CTRS CA	Quote
8504855	GM-04855	HEAD, H202T 240V RTD 1.50 CTRS CA	Quote
8506147	GM-74597	HEAD, H202T 240V RTD 2.00 CTRS CA	Quote
274597	GM-74597	HEAD, H202T 240V RTD 2.31 CTRS CA	Quote
714500	GM-14500	HEAD, H202T 240V RTD 2.31 CTRS IA	Quote
1060391	GM-60391	HEAD, H202T 240V RTD 2.31 CTRS IA	Quote
8504846	GM-04846	HEAD, H202T 240V RTD 2.31 CTRS CA	Quote
272323	GM-72323	HEAD, H202T 240V RTD 2.31 CTRS CA	Quote
8509277	GM-09277	HEAD, H202T 240V RTD 3.00 CTRS IA	Quote
810112	GM-10112	HEAD, H202T ZC12 240V RTD 0.88 CTRS CA	Quote
103225	GM-03225	HEAD, H202T ZC16 240V RTD 2.30 CTRS CA	Quote
103226	GM-03226	HEAD, H202T ZC20 240V RTD 2.30 CTRS CA	Quote
715663	GM-15663	HEAD, H202T ZC12 240V RTD 3.00 CTRS CA	Quote

APPLICATORS



Replacement for Nordson Multi Module H200 Applicators - Glenmar Multi G100 Applicators

Compatible with 2300/3000, ProBlue and DuraBlue melters, this multi applicator delivers precise and consistent hot melt dispensing. Offered in various spacing options, with standard, washdown, common, or independent air configurations available.

Need a custom applicator?
Let Glenmar design a solution tailored to your specific application.

NORDSON	GLENMAR	DESCRIPTION	
714867	GM-14867	HEAD, H203T 240V RTD. 0.88 CTRS IA	Quote
714870	GM-14870	HEAD, H203T 240V RTD. 0.88 CTRS IA	Quote
8505911	GM-05911	HEAD, H203T 240V RTD. 0.88 CTRS IA	Quote
131436	GM-31436	HEAD, H203T 240V RTD. 0.88 CTRS CA	Quote
714517	GM-14517	HEAD, H203T 240V RTD. 1.50 CTRS CA	Quote
728126	GM-28126	HEAD, H203T 240V RTD. 1.50 CTRS CA	Quote
714486	GM-14486	HEAD, H204T 240V RTD. 0.88 CTRS CA	Quote
1060876	GM-60876	HEAD, H204T 240V RTD. 0.88 CTRS CA	Quote
8504867	GM-04867	HEAD, H204T 240V RTD. 0.88 CTRS CA	Quote
8508429	GM-08429	HEAD, H204T 240V RTD. 0.88 CTRS CA	Quote
715646	GM-15646	HEAD, H204T 240V RTD. 0.88 CTRS IA	Quote
8511183	GM-11183	HEAD, H204T 240V RTD. 0.88 CTRS IA	Quote
714476	Zoho CRM GM-14476	HEAD, H204T 240V RTD. 0.88 CTRS IA	Quote

APPLICATORS

NORDSON	GLENMAR	DESCRIPTION	
809398	GM-09398	HEAD, H204T 240V RTD. 0.88/1.50/0.88 CTRS CA	Quote
224946	GM-24946	HEAD, H204T 240V RTD. 0.88/1.50/0.88 CTRS CA	Quote
274600	GM-74600	HEAD, H204T 240V RTD. 0.88/1.50/0.88 CTRS CA	Quote
8504840	GM-04840	HEAD, H204T 240V RTD. 0.88/1.50/0.88 CTRS CA	Quote
8504844	GM-04844	HEAD, H204T 240V RTD. 0.88/1.50/0.88 CTRS CA	Quote
8506913	GM-06913	HEAD, H204T 240V RTD. 0.88/1.50/0.88 CTRS IA	Quote
276775	GM-76775	HEAD, H204T 240V RTD. 0.88/1.50/0.88 CTRS IA	Quote
272325	GM-72325	HEAD, H204T 240V RTD. 0.88/1.50/0.88 CTRS CA	Quote
274609	GM-74609	HEAD, H204T 240V RTD. 1.62/2.31/1.62 CTRS CA	Quote
111547	GM-11547	HEAD, H204T 240V RTD. 2.00/0.88/0.88 CTRS IA	Quote
8514329	GM-14329	HEAD, H206T 240V RTD	Quote
714523	GM-14523	HEAD, H206T 240V RTD 0.88 CTRS CA	Quote
8505944	GM-14523	HEAD, H206T 240V RTD 0.88 CTRS CA	Quote
724070	GM-24070	HEAD, H206T 240V RTD 1.50 CTRS CA	Quote
714698	GM-14698	HEAD, H206T 240V RTD 1.50 CTRS CA	Quote
8505951	GM-05951	HEAD, H206T 240V RTD 1.50 CTRS CA	Quote
116672	GM-16672	HEAD, H206T 240V RTD 0.88/1.50/0.88 CTRS CA	Quote
8505953	GM-16672	HEAD, H206T 240V RTD 0.88/1.50/0.88 CTRS CA	Quote
715471	GM-15471	HEAD, H208T 240V RTD 0.88 CTRS CA	Quote
8506752	GM-06752	HEAD, H208T 240V RTD 0.88 CTRS CA	Quote
274603	GM-74603	HEAD, H208T 240V RTD 0.88/1.50/0.88 CTRS CA	Quote
8505280	GM-05280	HEAD, H208T 240V RTD 0.88/1.50/0.88 CTRS CA	Quote
272327	GM-72327	HEAD, H208T 230V RTD 0.88/1.50/0.88 CTRS CA	Quote

APPLICATORS



Replacement for Nordson H200LP/H400LP Low Profile Applicators - Glenmar G100LP Applicators

Compatible with 2300/3000, ProBlue and DuraBlue melters, this Low Profile applicator delivers precise and consistent hot melt dispensing. Offered in various spacing options, with standard, washdown, common, or independent air configurations available.

*Need a custom applicator?
Let Glenmar design a solution tailored to your specific application.*

NORDSON	GLENMAR	DESCRIPTION	
276440	GM-76440	HEAD, H202TLP 240V RTD - Low Profile	Quote
1054947	GM-54947	HEAD, H202TLP 240V RTD - Low Profile	Quote
276468	GM-76468	HEAD, H202TLP 240V RTD - Low Profile	Quote
276779	GM-76779	HEAD, H202TLP 240V RTD - Low Profile	Quote
224943	GM-24943	HEAD, H402TLP 240V RTD - Low Profile	Quote
224936	GM-24936	HEAD, H442TLP 240V RTD AO/AC - Low Profile	Quote
276541	GM-76541	HEAD, H204TLP 240V RTD - Low Profile	Quote
1051935	GM-51935	HEAD, H204TLP 240V RTD - Low Profile	Quote
302956	GM-02956	HEAD, H204TLP 240V RTD - Low Profile	Quote
276780	GM-76780	HEAD, H204TLP 240V RTD - Low Profile	Quote
302958	GM-02958	HEAD, H204TLP 240V RTD - Low Profile	Quote
224947	GM-24947	HEAD, H404TLP 240V RTD - Low Profile	Quote
326586	GM-24947	HEAD, H444TLP 240V RTD AO/AC - Low Profile	Quote
803864	GM-03864	HEAD, H206TLP 240V RTD - Low Profile	Quote
274594	GM-74594	HEAD, H208TLP 240V RTD 0.88 CTRS - Low Profile	Quote

APPLICATORS



Replacement for Nordson Multi Module H20Applicators - Glenmar Multi G10 Applicators

Compatible with 2300/3000, ProBlue and DuraBlue melters, this applicator delivers precise and consistent hot melt dispensing. Offered in various spacing options, with standard, washdown, common, or independent air configurations available.

*Need a custom applicator?
Let Glenmar design a solution tailored to your specific application.*

NORDSON	GLENMAR	DESCRIPTION	
274702	GM-74702	HEAD, H20T 240V RTD	Quote
276778	GM-76778	HEAD, H20T 240V RTD	Quote
136537	GM-36537	HEAD, H20T 240V RTD	Quote
274728	GM-74728	HEAD, H20T 240V RTD	Quote
120664	GM-20664	HEAD, H20T 240V RTD	Quote
815138	GM-15138	HEAD, H20T 240V RTD W/ FILTER	Quote

FAST SHIPPING!

+1 908-561-9920

info@glenmartech.com - glenn.kiesel@gmail.com
1233 North Ave, Plainfield, NJ 07062, USA



APPLICATORS



Replacement for Nordson Multi Module H200/H400 AO/AC Applicators - Glenmar Multi G100 AO/AC Applicators

Compatible with 2300/3000, ProBlue and DuraBlue melters, this multi applicator delivers precise and consistent hot melt dispensing. Offered in various spacing options, with standard, washdown, common, or independent air configurations available.

*Need a custom applicator?
Let Glenmar design a solution tailored to your specific application.*

NORDSON	GLENMAR	DESCRIPTION	
326540	GM-26540	HEAD, H201T 240V RTD W/ Solenoid V.	Quote
8505756	GM-05756	HEAD, H201T 240V RTD W/ Solenoid V.	Quote
8505768	GM-05768	HEAD, H201T 240V RTD W/ Solenoid V.	Quote
8505769	GM-05769	HEAD, H201T 240V RTD W/ Solenoid V.	Quote
326584	GM-26584	HEAD, H202T 240V RTD W/ Solenoid V.	Quote
326585	GM-26585	HEAD, H202T 240V RTD RTD 1.5 CTRS W/ Solenoid V.	Quote
326545	GM-26545	HEAD, H202T 240V RTD RTD 2.3 CTRS W/ Solenoid V.	Quote
326587	GM-26587	HEAD, H204T 240V RTD W/ Solenoid V.	Quote
326546	GM-26546	HEAD, H204T 240V RTD RTD 1.5 CTRS W/ Solenoid V.	Quote
224937	GM-24937	HEAD, H206T 240V RTD W/ Solenoid V.	Quote
326547	GM-26547	HEAD, H208T 240V RTD W/ Solenoid V.	Quote

HAND APPLICATORS

HG8000 HAND GUND DIAGRAM

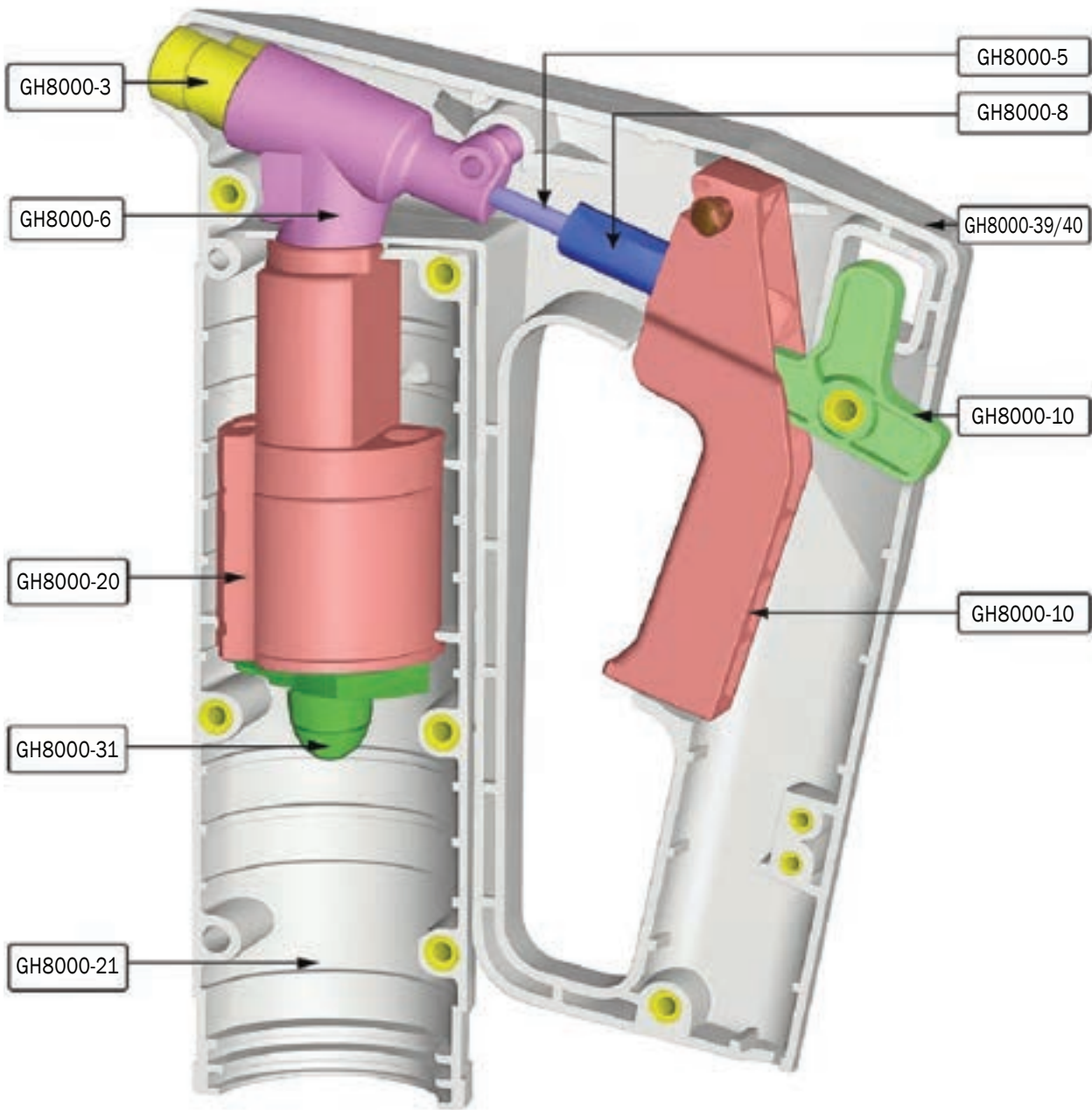

CONTACT US NOW!

+1 908-561-9920
info@glenmartech.com - glenn.kiesel@gmail.com
1233 North Ave, Plainfield, NJ 07062, USA



HAND APPLICATORS



Replacement for Nordson Series AD-31 Extrusion Hand-Held Applicator

Our replacement for Nordson AD-31 extrusion applicator offers precise hot melt dispensing. It supports standard and extended nozzles with varying orifice sizes, and includes a 360° swivel connector to prevent hose twisting.

RTD or preset temperature sensors ensure consistent adhesive flow, even with high-viscosity or filled materials.



NORDSON	GLENMAR	DESCRIPTION	PRICE
274765	GM-74765	AD-31 Handgun 240V - RTD	\$726.00
174933	GM-74933	AD-31Handgun 240V - RTD T-PA	\$726.00
179766	GM-79766	AD-31Handgun 240V - RTD	\$726.00
1001321	GM-01321	AD-31Handgun 240V - RTD T-PA	\$726.00
175299	GM-75299	AD-31Handgun 200V - RTD T-PA	\$726.00
307712	GM-07712	AD-31Handgun 120V - RTD	\$726.00
274968	GM-74968	AD-31 Single Bead extended nozzle 0.041	\$74.50
274969	GM-74969	AD-31 Single Bead extended nozzle 0.061	\$74.50
274970	GM-74970	AD-31 Single Bead extended nozzle 0.091	\$74.50

HAND APPLICATORS



GH8000 - 180R (224911)
O-Ring
\$0.60



GH8000 - 19 (986305)
Clip, Wire - Retaining
\$0.75



GH8000 - (1020559, 274708)
Sleeve, Pivot
\$75.00



GH8000 - (271627)
Shell, Pivot Sleeve Set
\$38.00



GH8000 - 22 (939586C)
Terminal Block
\$13.75



GH8000 - 23 (986322)
Retaining, Ring, Round
\$0.60



GH8000 - (940121)
O-Ring Viton
\$0.60



GH8000 - 25 (954012)
Back-up Ring, Single
\$0.60



GH8000 - 26 (272404)
Bearing, Thrust, with grease
\$9.00



GH8000 - 27 (986016)
Retaining ring (Heavy Duty) 5/8 in.
\$0.72



GH8000 - 28 (271631)
Spring, conical
\$3.45



GH8000 - 29 (983111)
Washer, lock, split (8)
\$0.32



GH8000 - 30 (981082)
Screw, pan, 8-32 in. x 1.25 in
\$1.75



GH8000 - (272791, 271688)
Connector, Swivel 5/8 in hose
\$20.02



GH8000 - (1028826)
Kit, RTD, 120 OHMs, Nickel
\$36.00



GH8000 - 33 (981100)
Screw, Fillister, 5-40 in x 0.25 in
\$0.60



GH8000 - 35 (981082)
Screw, Pan, 6-32 in x 0.25 in
\$0.60



GH8000 - 36 (182045)
Bearing Sleeve
\$7.45



GH8000 - 37 (182045)
Trigger, Safety Gun
\$12.00



GH8000 - 38 (271620)
Spring, Safety, Wave
\$2.99



GH8000 - 39/40 (182049)
Shell, fun
\$89.45



GH8000 - 41 (981800)
Cap Screw Fillister 6-32 in x 0.5 in
\$0.85

HAND APPLICATORS



Replacement for Nordson AD-31 Swirl and Wide Pattern Swirl Hand-Held Applicators

Glenmar's replacement for Nordson AD-31 swirl and wide pattern swirl applicators deliver a helical spray pattern ideal for pressure sensitive adhesives and delicate substrates.

With adjustable pattern widths from 6 to 152 mm and a lightweight 0.80 kg design, they offer excellent control and ease of use.



NORDSON	GLENMAR	DESCRIPTION	PRICE
137217	GM-37217	AD-31 STR-WP, RTD, 240V, 80 W, 5/16 in. Wide spray-type applicator	\$1,185.00
101206	GM-01206	AD-31STR RTD w/valve, 240V, 80 W, 5/16 in. Swirl-type applicator	\$1,185.00
101207	GM-01207	AD-31SCR w/valve, RTD, 240V, 80 W, 5/16 in. Swirl-type applicator	\$1,185.00

NORDSON	GLENMAR	DESCRIPTION	PRICE
1046125	GM-46125	Unibody Spray/Swirl Wide Nozzle Without O-ring 0.012" - G100FDS STEEL (12-Hole)	\$176.00
1046128	GM-46128	Unibody Spray/Swirl Wide Nozzle Without O-ring 0.018" - G100FDS STEEL (12-Hole)	\$176.00
1046154	GM-46154	Unibody Spray/Swirl Wide Nozzle Without O-ring 0.030" - G100FDS STEEL (12-Hole)	\$176.00

HAND APPLICATORS



GH8000-1
Tapered Cap/Plug
\$1.70



GH8000-2 (940133)
O-Ring, Viton
\$0.60



GH8000-3 (271629)
Seat
\$23.75



GH8000-4 (152987)
Seal, Ring, Seat
\$1.47



GH12000-17
Shell, Gun, Swirl
\$96.95



GH8000-5 (271877)
Cartridge, Packing
\$67.15



GH8000-6 (273548, 273002)
Body, Gun
\$67.13



GH12000-05
Cartridge Assembly
\$72.10



GH8000-7 (984120)
Nut, Hex 10-32
\$0.72



GH8000-8 (281616)
Linkage, Trigger
\$5.50



GH8000-9 (271617)
Spring, Compression,
\$3.45



GH8000-10 (182046)
Trigger, Gun
\$10.01



GH12000-10
Cam
\$17.15



GH8000-11 (985216)
Pin, Dowel, 0250x1.25 in
\$3.45



GH8000-13 (983526)
Washer, Lock, Split, 4
\$0.35



GH8000-15 (271626)
Plate, bearing
\$3.45



GH8000-16 (981817)
Screw, Shoulder
\$1.70



GH12000-14
Air Valve with Nipple
\$44.75



GH8000-17
Ceramic Wire Nut
\$1.70



GH8000-18-120 (224914)
Heater, 120 VAC, 65W
\$27.35



GH8000-18-240 (224911)
Heater, 240 VAC, 80W
\$27.40



GH8000-18-PT100
Platinum, 100 ohms
\$36.05



GH12000-15
Air Connector
\$59.75



GH12000-04
Air-Assembly
\$59.75



GH12000-11
Shoulder Cam Screw
\$5.2



GH12000-12
Cam/Air Valve
\$59.75



GH12000-18
Air Input Assembly (#10 #16)
\$223.00



GH12000-03
Seat
\$29.85



GH12000-13
4-40x3/8" Screw
\$0.45



GH12000-02
O-Ring
\$0.72



GH12000-16
Hex Nipple
\$6.89



GH12000-09
Tubing
\$6.89

FILTERS

Replacement for Nordson In-line Filters: 45°, 90°, Straight

Glenmar's replacement for Nordson In-line: 45°, 90°, and Straight filters features a compact angled body for tight installations. Precision-machined housing and replaceable stainless-steel mesh screen to maintain optimal adhesive flow.



NORDSON	GLENMAR	DESCRIPTION	PRICE
274989	GM-74989	45° In-line filter - 50 Mesh	\$60.00
274991	GM-74990	45° In-line filter - 100 Mesh	\$60.00
274990	GM-74991	45° In-line filter - 200 Mesh	\$60.00
274287	GM-74287	90° In-line filter - 50 Mesh	\$60.00
274288	GM-74288	90° In-line filter - 100 Mesh	\$60.00
274289	GM-74289	90° In-line filter - 200 Mesh	\$60.00
274290	GM-74290	Straight In-line filter - 50 Mesh	\$60.00
274291	GM-74291	Straight In-line filter - 100 Mesh	\$60.00
274292	GM-74292	Straight In-line filter - 200 Mesh	\$60.00



NORDSON	GLENMAR	DESCRIPTION	PRICE
271598	GM-07233	Filter screen, 50 mesh	\$17.99
271599	GM-07234	Filter, screen, 100 mesh	\$17.99
271600	GM-07235	Filter screen, 200 mesh	\$17.99
274289	GM-07230	O-ring, 90° filter, 200 mesh	\$17.99

FILTERS

Replacement for Nordson Saturn Filters: 45°, 90°, Straight

Glenmar's replacement for Nordson Saturn: 45°, 90°, and Straight filters features a compact angled body for tight installations. Precision-machined housing and replaceable stainless-steel mesh screen to maintain optimal adhesive flow.



NORDSON	GLENMAR	DESCRIPTION	PRICE
1007233	GM-07233	45° Mars filter - 50 Mesh	\$52.00
1007234	GM-07234	45° Mars filter - 100 Mesh	\$52.00
1007235	GM-07235	45° Mars filter - 200 Mesh	\$52.00
1007230	GM-07230	90° Mars filter - 50 Mesh	\$52.00
1007231	GM-07231	90° Mars filter - 100 Mesh	\$52.00
1007232	GM-07232	90° Mars filter - 200 Mesh	\$52.00
1007033	GM-07033	Straight Mars filter - 50 Mesh	\$52.00
1007034	GM-07034	Straight Mars filter - 100 Mesh	\$52.00
1007035	GM-07035	Straight Mars filter - 200 Mesh	\$52.00



Replacement for Nordson Saturn Filter Mesh: 50, 100, 200

Glenmar's replacement for Nordson Saturn filter mesh is designed for precision filtration within adhesive systems. Manufactured to OEM standards, it fits directly into compatible in-line filter bodies and is available in multiple mesh sizes

\$16.65

FILTERS

G900FILTANK - 100



Triple mesh tank filter. Compatible with Nordson Pro Blue. Designed to capture fine contaminants and protect pump and hose components, it features durable stainless steel mesh, high-temperature resistance, and secure fitment for consistent filtration and system

\$89.25

RTD

\$37.75

Heaters



Glenmar supplies high-quality cartridge heaters, RTDs, and cordsets for use in Nordson hot melt adhesive systems. Our heaters provide efficient, consistent heat transfer in tanks, manifolds, and hoses, while RTDs ensure precise temperature monitoring for optimal system performance. We also offer durable, high-temperature cordsets for reliable electrical connectivity and integration.

Please provide the following when ordering heaters:

- Diameter
- Wattage
- Voltage
- Lead Length

Example: 3/8" Diameter, 150 Watts, 240 Volts, 26-inch Black Teflon Leads

CORDSETS

We have all sizes, finishes, and voltages for any of your Nordson Compatible Cordset needs.

Electrical Nordson compatible cordset with RTD sensor for Nordson® applicator gun used on Model 2300/3000/ProBlue and DuraBlue heated hoses.



\$179.00

HOSES



Replacement for Nordson ProBlue 2300, and 3000 Series - Heated Hot Melt Hoses Standard 240V

Designed for consistent adhesive temperature control and durability in demanding applications. Compatible with Nordson 2000, IV, V, 3000, ProBlue®, and DuraBlue equipment (automatic and handgun). Built with rugged outer jacketing, precision heating elements, and high-temp insulation to ensure reliable adhesive flow and extended hose life.

Different lengths available:

NORDSON	GLENMAR	DESCRIPTION	PRICE
274790	GM-74790	Standard 240V Heated Hot Melt Hose - 2.00 Ft.	\$311.00
274791	GM-74791	Standard 240V Heated Hot Melt Hose - 4.00 Ft.	\$408.00
274792	GM-74792	Standard 240V Heated Hot Melt Hose - 6.00 Ft.	\$505.00
274793	GM-74793	Standard 240V Heated Hot Melt Hose - 8.00 Ft.	\$631.00
274794	GM-74794	Standard 240V Heated Hot Melt Hose - 10.00 Ft.	\$756.00
274795	GM-74795	Standard 240V Heated Hot Melt Hose - 12.00 Ft.	\$1,067.00
274796	GM-74796	Standard 240V Heated Hot Melt Hose - 16.00 Ft.	\$1,144.00
223836	GM-23836	Standard 240V Heated Hot Melt Hose - 20.00 Ft.	\$1,319.00
274797	GM-74797	Standard 240V Heated Hot Melt Hose - 24.00 Ft.	\$1,649.00



CONTACT US NOW!

+1 908-561-9920
 info@glenmartech.com - glenn.kiesel@gmail.com
 1233 North Ave, Plainfield, NJ 07062, USA



HOSES



Replacement for Nordson ProBlue 2300, and 3000 Series - Heated Hot Melt Hoses Water-Wash Hoses, 240V

Designed for consistent adhesive temperature control and durability in demanding applications. Compatible with Nordson 2000, IV, V, 3000, ProBlue®, and DuraBlue equipment (automatic and handgun). Built with rugged outer jacketing, precision heating elements, and high-temp insulation to ensure reliable adhesive flow and extended hose life.

Different lengths available:

NORDSON	GLENMAR	DESCRIPTION	PRICE
276739	GM-76739	Water-Wash Heated Hot Melt Hose - 2.00 Ft.	\$388.00
276740	GM-76740	Water-Wash Heated Hot Melt Hose - 4.00 Ft.	\$475.00
276741	GM-76741	Water-Wash Heated Hot Melt Hose - 6.00 Ft.	\$601.00
276742	GM-76742	Water-Wash Heated Hot Melt Hose - 8.00 Ft.	\$728.00
276743	GM-76743	Water-Wash Heated Hot Melt Hose - 10.00 Ft.	\$862.00
276744	GM-76744	Water-Wash Heated Hot Melt Hose - 16.00 Ft.	\$1,222.00
223837	GM-23837	Water-Wash Heated Hot Melt Hose - 20.00 Ft.	\$1,658.00
276745	GM-76745	Water-Wash Heated Hot Melt Hose - 24.00 Ft.	\$2,036.00

NORDSON	GLENMAR	DESCRIPTION	PRICE
274798	GM-74792	AD-31 Heated Hot Melt Hose - 8.00 Ft.	\$756.00
115833	GM-74793	AD-31 Heated Hot Melt Hose - 10.00 Ft.	\$931.00
130785	GM-74794	AD-31 Heated Hot Melt Hose - 12.00 Ft.	\$1,067.00
274799	GM-74796	AD-31 Heated Hot Melt Hose - 16.00 Ft.	\$1,300.00
		AD-31 Heated Hot Melt Hose - 20.00 Ft.	\$1,610.00
101354	GM-74797	AD-31 Heated Hot Melt Hose - 24.00 Ft.	\$1,929.00

PROBLUE PUMP



Replacement for Nordson ProBlue Hot Melt Pump

Glenmar's replacement pump is fully compatible with Nordson ProBlue 4, 7, and 10 melters. Featuring a 14:1 pressure ratio, it delivers up to 32.7 kg/hr (72 lb/hr) of adhesive with consistent flow and low shear. Operating within an air range of 10–60 psi, it provides reliable pressure control for demanding hot melt applications.

Built in the USA with OEM grade materials, the pump includes a double-acting piston design for smooth, long lasting performance. It installs directly into existing systems with no modifications, making it an ideal solution for packaging, hygiene, and nonwoven production lines.

NORDSON	GLENMAR	DESCRIPTION	PRICE
1028303	GM-28303	Service, Pump Assembly, piston P4, P7, P10, Replacement 15:1	\$3,000.00
1028303	GM-28303	Rebuild Service, Pump Assembly, piston P4, P7, P10, Replacement 15:1	\$1,500.00
1028304	GM-28304	Rebuild Kit, pump, piston, (P4/P7/P10)	\$85.80
1024465	GM-24465	Pump Shifter assembly G1/8	\$646.00
1016339	GM-16339	Frame pump machined	\$157.00
166880	GM-66880	Shifter fork assembly	\$167.20
503696	GM-03696	Cage Ball assembly	\$15.00
276024	GM-76024	Valve assembly, drain	\$156.20
1021955	GM-21955	Adapter Filter Bung assembly	\$85.80
1028305	GM-28305	100-Mesh Saturn filter assembly	\$79.00
1017307	GM-17307	Insulator Pump	\$18.86
1021270	GM-21270	Plate, Filter, Anti rotate	\$79.00

HOSES



Replacement for ITW Dynatec Hot-Melt Heated Hoses

At Glenmar Technology, we supply Replacements for ITW Dynatec hoses, which are electrically heated flexible conduits designed to transfer hot melt adhesive from the adhesive supply unit (ASU) to applicators such as heads or handguns.

Different lengths available

ITW	GLENMAR	DESCRIPTION	PRICE
105187	GM-05187	Hot-melt Heated Hose DN8 PT100 L 9,2 m	\$1,170.00
106216	GM-06216	Hot-melt Heated Hose DN8 PT100 L 11,1 m	\$1,170.00



CONTACT US NOW!

+1 908-561-9920
info@glenmartech.com - glenn.kiesel@gmail.com
1233 North Ave, Plainfield, NJ 07062, USA



ITW DYNATEC MINI GUNS



Replacement for ITW Dynatec Single & Dual Mini Gun

Glenmar Technology's G300 Single and Dual Gun are replacements for ITW mini gun with filter. Can operate at temperatures of up to 450 °F (232 °C). Open air/close module provides clean applications.

• Single **\$840.00**

• Dual **\$1,010.00**

Replacement for ITW Dynatec Micro Optima Module

The G300 Mini Zero Module is a direct replacement for the ITW Micro Optima Module. Air open, spring close (AOSC).

Compatible with ITW BF Micro Series.

Different orifice sizes available:
0.012, 0.014, 0.016, 0.018, 0.020, 0.024, 0.035

\$270.00



Replacement for ITW Dynatec MicroBead Module 7050

Glenmar Technology G300 MINISTD module is a direct replacement for ITW Dynatec Microbead Module 7050.

This module ensures precise adhesive application (400+ psi) with a clean cutoff. Its air-open/air-close prevents stringing, while a platinum sensor provides superior temperature control and durability.

\$210.00

PRODUCT CATALOG 2026

Modules, Nozzles, Guns, Hoses, Rebuild Kits

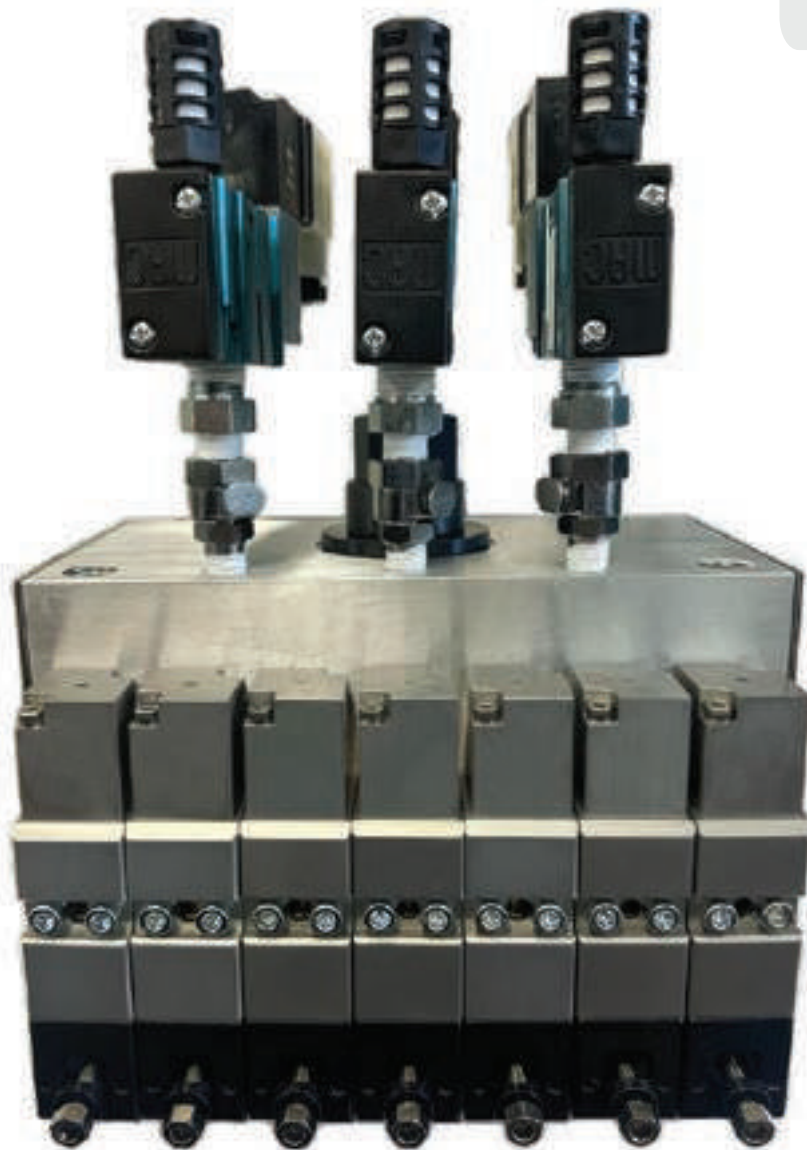

NONWOVEN PARTS

MODULES



Replacement for Nordson UM22, UM25 & UM50 Modules

Glenmar's replacements for Nordson UM22, UM25, and UM50 slot applicator modules, designed for precise hot melt adhesive application in nonwoven and packaging systems. Manufactured in the USA, these modules offer reliable sealing, consistent flow, and long service life.

Fully compatible with Nordson systems and ideal for use in hygiene converting lines.

NORDSON	GLENMAR	DESCRIPTION	PRICE
1048992	GM-48992	UM25 Standard Module - Adjustable Cap	\$395.00
1048996	GM-48996	UM25 Standar Module - Fixed Cap	\$395.00
1059601	GM-59601	UM50 Standard Module - Fixed Cap	\$575.00
1049482	GM-49482	UM22 Standard Module - Fixed Cap	\$395.00
1048999	GM-48999	UM22 Standard Module - Adjustable Cap	\$395.00
1049909	GM-49909	UM22/25/50 Minor Rebuild Kit	\$70.00
1049908	GM-49908	UM22/25/50 Major Rebuild Kit	\$90.00

MODULES

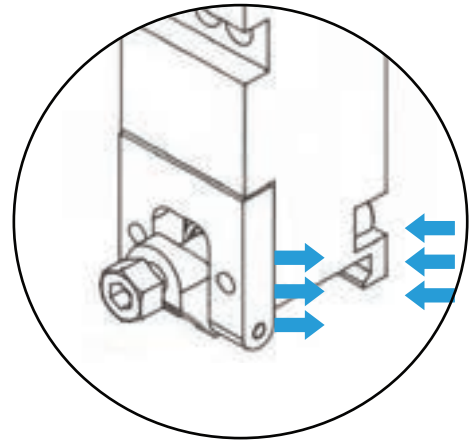

7075 ALUMINUM

Its superior strength-to-weight ratio and excellent fatigue resistance make it a preferred material for manufacturing our replacement for Nordson universal modules.

STAINLESS STEEL

The added strength and durability of the Stainless Steel version of our replacements for Nordson Universal Modules help prevent accidental breakage of the back Ear Clip caused by overtightening the front screw when installing a new nozzle. This is just one of several benefits this upgrade provides.

NORDSON	GLENMAR	DESCRIPTION	PRICE
1048992	GM-48992A	UM25 7075 Aircraft grade aluminum Module - Adjustable Cap	\$420.00
1048996	GM-48996A	UM25 7075 Aircraft grade aluminum Module - Fixed Cap	\$420.00
1059601	GM-59601A	UM50 7075 Aircraft grade aluminum Module - Fixed Cap	\$600.00
1097304	GM-97304	UM25 Stainless Steel Module - Adjustable Cap	\$585.00
1097305	GM-97305	UM25 Stainless Steel Module - Fixed Cap	\$585.00
1502934	GM-02934	UM50 Stainless Steel Module - Fixed Cap	\$800.00
1054932	GM-54932	UM22 Stainless Steel Module - Fixed Cap	\$585.00

MODULES



Replacement for Nordson SpeedCoat II Control Module

High-performance replacement for Nordson Speed-Coat control module. Compatible with Universal applicators, it supports CF, Summit, SureWrap, Allegro, Control Coat, MiniBead, and Saturn nozzles.

NORDSON	GLENMAR	DESCRIPTION	PRICE
7162039	GM-62039	Speed-Coat II Control Module	\$575.00
7162040	GM-62040	Speed-Coat II Control Module, 24V Booster	\$1,250.00
7162079	GM-62079	Speed-Coat II Control Module TiN Version, 24V Booster	\$1,250.00
7162059	GM-62059	Speed-Coat II Control Module	\$575.00
7162060	GM-62060	Speed-Coat II Control Module, 24/48V	\$1,250.00
7162090	GM-62090	Speed-Coat II Control Module TiN Version, 24/48V	\$1,250.00
7173117	GM-73117	Rebuild Kit Minor SpeedCoat II Control Module	\$225.00
7173115	GM-73115	Rebuild Kit Major SpeedCoat II Control Module	\$390.00

MODULES

Worn out SpeedCoat Module



BEFORE

Refurbished SpeedCoat Module



AFTER

Refurbishment Services

At Glenmar Technology, we specialize in refurbishing worn-out Speed-Coat modules, Universal modules, entire applicators, and a wide range of hot melt components. Our expert team restores your equipment to like-new condition, cleaned, rebuilt, and fully tested to ensure reliable performance for your nonwoven applications.

These include hygiene products, filtration media, medical disposables, and paper converting operations.

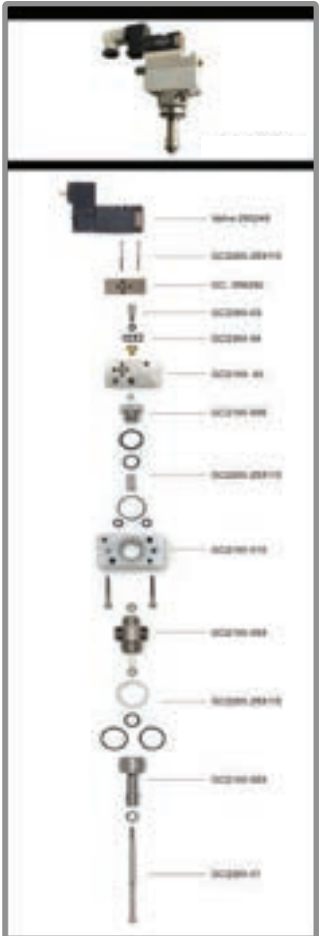
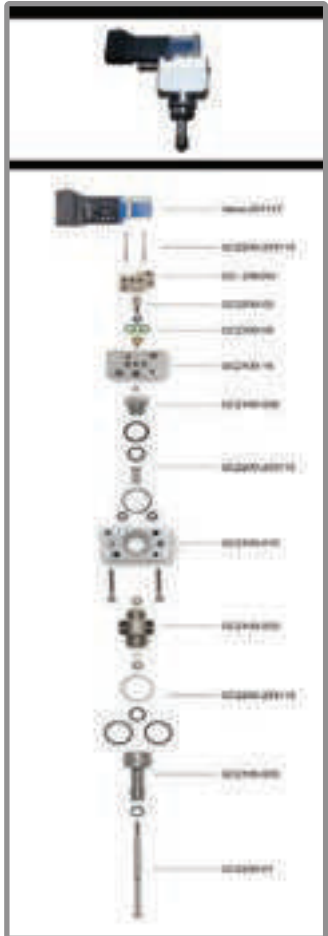

MODULES



Replacement for Nordson EP10 modules

Glenmar's replacement for Nordson EP10 module is designed for precise and consistent hot melt adhesive application in nonwoven and hygiene production lines. This high-performance module features a 0.30 mm needle stroke, fast actuation, and reliable shut-off control, ensuring clean adhesive patterns even at high speeds.

NORDSON	GLENMAR	DESCRIPTION	PRICE
7106945	GM-06945	EP10 Control Module	\$705.00
401784	GM-01784	EP10 Control Module	\$705.00

FAST SHIPPING!

+1 908-561-9920
info@glenmartech.com - glenn.kiesel@gmail.com
1233 North Ave, Plainfield, NJ 07062, USA



GLENMAR TECHNOLOGY

Your trusted source for Nordson and ITW Dynatec
Replacement parts



We offer exceptional quality at highly competitive prices

The prices listed in this catalog reflect our standard retail rates; however, we actively collaborate with distributors and bulk buyers to offer tailored pricing and volume discounts.

Samples available for testing, so you can confidently evaluate the quality and compatibility of our parts.

We are happy to collaborate with your company and become your trusted source for all your Nordson and ITW Dynatec replacement part needs including modules, nozzles, applicators, filters, rebuild kits, and more. Contact us today to discuss how we can support your business with the best parts at the most competitive prices.



FAST SHIPPING!

+1 908-561-9920
info@glenmartech.com - glenn.kiesel@gmail.com
1233 North Ave, Plainfield, NJ 07062, USA



NOZZLES



Replacement for Nordson Universal CF Nozzle

High-precision replacement for Nordson Universal CF Nozzle, it ensures controlled fiberization, consistent spray patterns, and optimal adhesive distribution.

Available from 0.012" to 0.030"

NORDSON	GLENMAR	DESCRIPTION	PRICE
1053960	GM-53960	Universal CF Nozzle 0.012"	\$180.00
1053964	GM-53964	Universal CF Nozzle 0.012"	\$180.00
1053961	GM-53961	Universal CF Nozzle 0.016"	\$180.00
1053966	GM-53966	Universal CF Nozzle 0.016"	\$180.00
1054730	GM-54730	Universal CF Nozzle 0.018"	\$180.00
1054731	GM-54731	Universal CF Nozzle 0.018"	\$180.00
1049565	GM-49565	Universal CF Nozzle 0.020"	\$180.00
1052500	GM-52500	Universal CF Nozzle 0.020"	\$180.00
1053962	GM-53962	Universal CF Nozzle 0.025"	\$180.00
1053967	GM-53967	Universal CF Nozzle 0.025"	\$180.00
1053963	GM-53963	Universal CF Nozzle 0.030"	\$180.00
1053968	GM-53968	Universal CF Nozzle 0.030"	\$180.00



DESCRIPTION

Jm Labs Style UM Nozzle - Meltblown Nozzle

PRICE

\$200.00

NOZZLES



Replacement for Nordson Summit Nozzle

Our Replacement for Nordson Universal Summit nozzles are available in brass, stainless steel and heat-treated stainless steel with TiCN coating.

NORDSON	GLENMAR	DESCRIPTION	PRICE
1035886	GM-35886	Summit Nozzle Full Coverage - Brass	\$175.00
1035887	GM-35887	Summit Nozzle Full coverage - Stainless Steel	\$200.00
1035888	GM-35888	Summit Nozzle Full coverage - Tich	\$245.00
1035876	GM-35876	Summit Nozzle 1 Orifice Center - Brass	\$175.00
1035875	GM-35875	Summit Nozzle 1 Orifice L/R - Brass	\$175.00
1035878	GM-35878	Summit Nozzle 1 Orifice Center - Stainless Steel	\$200.00
1035877	GM-35877	Summit Nozzle 1 Orifice L/R - Stainless Steel	\$200.00
1035880	GM-35880	Summit Nozzle 2 Orifices Center - Brass	\$175.00
1035879	GM-35879	Summit Nozzle 2 Orifices L/R - Brass	\$175.00
1035882	GM-35882	Summit Nozzle 2 Orifices Center - Stainless Steel	\$200.00
1035881	GM-35881	Summit Nozzle 2 Orifices L/R - Stainless Steel	\$200.00
1035883	GM-35883	Summit Nozzle 3 Orifices Center - Brass	\$175.00
1035629	GM-35629	Summit Nozzle 3 Orifices L/R - Brass	\$175.00
1035885	GM-35885	Summit Nozzle 3 Orifices Center - Stainless Steel	\$200.00
1035884	GM-35884	Summit Nozzle 3 Orifices L/R - Stainless Steel	\$200.00

GLENMAR TECHNOLOGY

Your trusted source for Nordson and ITW Dynatec
Replacement parts

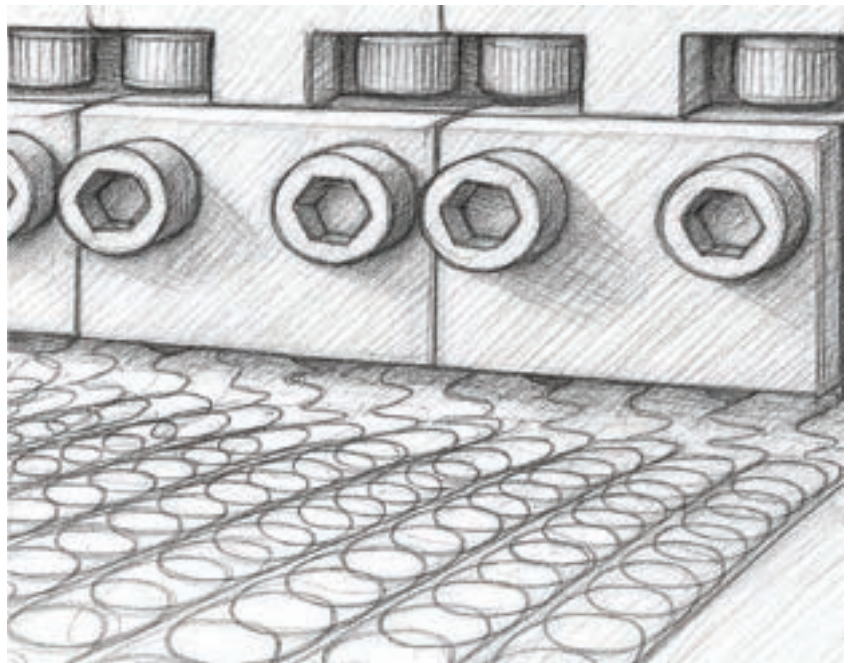
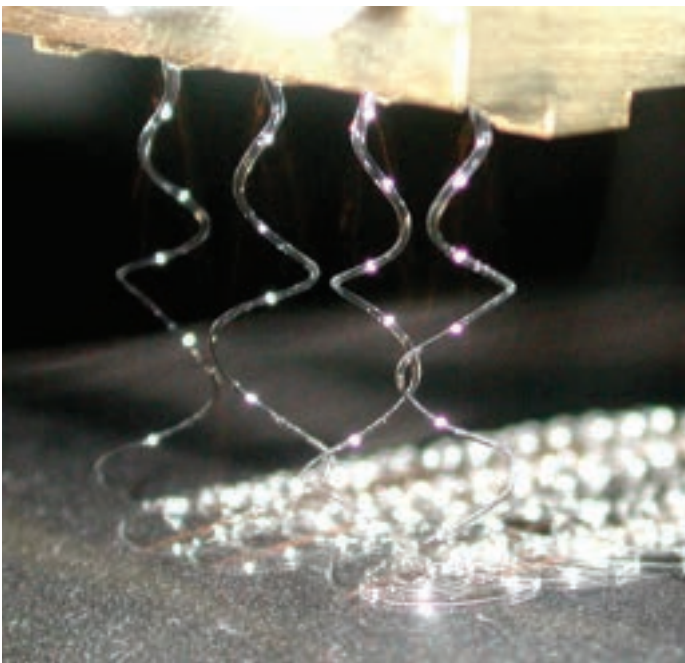

FAST SHIPPING!

+1 908-561-9920

info@glenmartech.com - glenn.kiesel@gmail.com
1233 North Ave, Plainfield, NJ 07062, USA



NOZZLES



Replacement for Nordson Steel Unibody Spray Standard CF Nozzle (6-Hole)

Nordson Controlled Fiberization (CF) nozzles deliver consistent, accurate adhesive patterns for a wide variety of hot melt adhesive spray applications.

NORDSON	GLENMAR	DESCRIPTION	PRICE
753488	GM-53488	Unibody Spray/Swirl Nozzle Without O-ring 0.012" – G100FDS STEEL (6-Hole)	\$104.00
753489	GM-53489	Unibody Spray/Swirl Nozzle Without O-ring 0.014" – G100FDS STEEL (6-Hole)	\$104.00
753491	GM-53491	Unibody Spray/Swirl Nozzle Without O-ring 0.016" – G100FDS STEEL (6-Hole)	\$104.00
753492	GM-53492	Unibody Spray/Swirl Nozzle Without O-ring 0.018" – G100FDS STEEL (6-Hole)	\$104.00
753493	GM-53493	Unibody Spray/Swirl Nozzle Without O-ring 0.020" – G100FDS STEEL (6-Hole)	\$104.00
753494	GM-53494	Unibody Spray/Swirl Nozzle Without O-ring 0.025" – G100FDS STEEL (6-Hole)	\$104.00
753495	GM-53495	Unibody Spray/Swirl Nozzle Without O-ring 0.030" – G100FDS STEEL (6-Hole)	\$104.00
753496	GM-53496	Unibody Spray/Swirl Nozzle Without O-ring 0.040" – G100FDS STEEL (6-Hole)	\$104.00



Replacement for Nordson Steel Unibody Spray Wide CF Nozzle (6-Hole)

Nordson Controlled Fiberization (CF) nozzles deliver consistent, accurate adhesive patterns for a wide variety of hot melt adhesive spray applications.

NORDSON	GLENMAR	DESCRIPTION	PRICE
181927	GM-81927	Unibody Spray/Swirl Wide Nozzle 0.012" – G100FDS STEEL Without O-ring	\$104.00
185533	GM-85533	Unibody Spray/Swirl Wide Nozzle 0.018" – G100FDS STEEL Without O-ring	\$104.00
1046158	GM-46158	Unibody Spray/Swirl Wide Nozzle 0.018" – G100FDS STEEL Without O-ring	\$104.00
754963	GM-54963	Unibody Spray/Swirl Wide Nozzle 0.020" – G100FDS STEEL Without O-ring	\$104.00
185534	GM-85534	Unibody Spray/Swirl Wide Nozzle 0.030" – G100FDS STEEL Without O-ring	\$104.00

NOZZLES



Replacement for Nordson Spray Standard/Wide CF Nozzle (12-Hole)

Nordson Controlled Fiberization (CF) nozzles deliver consistent, accurate adhesive patterns for a wide variety of hot melt adhesive spray applications.

NORDSON	GLENMAR	DESCRIPTION	PRICE
755957	GM-55957	Unibody Spray/Swirl Nozzle Without O-ring 0.012" - G100FDS BRASS (12-Hole)	\$118.00
756306	GM-56306	Unibody Spray/Swirl Nozzle Without O-ring 0.014" - G100FDS BRASS (12-Hole)	\$118.00
756307	GM-56307	Unibody Spray/Swirl Nozzle Without O-ring 0.016" - G100FDS BRASS (12-Hole)	\$118.00
755530	GM-55530	Unibody Spray/Swirl Nozzle Without O-ring 0.018" - G100FDS BRASS (12-Hole)	\$118.00
756308	GM-56308	Unibody Spray/Swirl Nozzle Without O-ring 0.020" - G100FDS BRASS (12-Hole)	\$118.00
756309	GM-56309	Unibody Spray/Swirl Nozzle Without O-ring 0.025" - G100FDS BRASS (12-Hole)	\$118.00
756115	GM-56115	Unibody Spray/Swirl Nozzle Without O-ring 0.030" - G100FDS BRASS (12-Hole)	\$118.00
756115	GM-56115	Unibody Spray/Swirl Nozzle Without O-ring 0.040" - G100FDS BRASS (12-Hole)	\$118.00

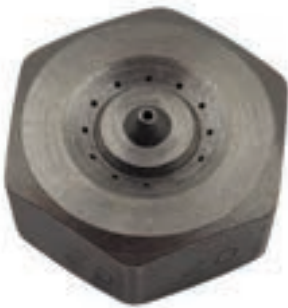

Replacement for Nordson Spray Standard/Wide CF Nozzle (12-Hole)

Nordson Controlled Fiberization (CF) nozzles deliver consistent, accurate adhesive patterns for a wide variety of hot melt adhesive spray applications.

NORDSON	GLENMAR	DESCRIPTION	PRICE
1046125	GM-46125	Unibody Spray/Swirl Wide Nozzle Without O-ring 0.012" - G100FDS STEEL (12-Hole)	\$176.00
1046128	GM-46128	Unibody Spray/Swirl Wide Nozzle Without O-ring 0.018" - G100FDS STEEL (12-Hole)	\$176.00
1046154	GM-46154	Unibody Spray/Swirl Wide Nozzle Without O-ring 0.030" - G100FDS STEEL (12-Hole)	\$176.00

NOZZLES

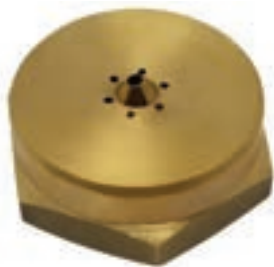

Replacement for Nordson Brass Unibody Spray Standard CF Nozzle (6-Hole)

Nordson Controlled Fiberization (CF) nozzles deliver consistent, accurate adhesive patterns for a wide variety of hot melt adhesive spray applications.

NORDSON	GLENMAR	DESCRIPTION	PRICE
152168	GM-52168	Unibody Spray/Swirl Nozzle Without O-ring 0.012" - G100FDS BRASS (6-Hole)	\$104.00
152169	GM-52169	Unibody Spray/Swirl Nozzle Without O-ring 0.014" - G100FDS BRASS (6-Hole)	\$104.00
152170	GM-52170	Unibody Spray/Swirl Nozzle Without O-ring 0.016" - G100FDS BRASS (6-Hole)	\$104.00
152171	GM-52171	Unibody Spray/Swirl Nozzle Without O-ring 0.018" - G100FDS BRASS (6-Hole)	\$104.00
152172	GM-52172	Unibody Spray/Swirl Nozzle Without O-ring 0.020" - G100FDS BRASS (6-Hole)	\$104.00
156698	GM-56698	Unibody Spray/Swirl Nozzle Without O-ring 0.025" - G100FDS BRASS (6-Hole)	\$104.00
152173	GM-52173	Unibody Spray/Swirl Nozzle Without O-ring 0.030" - G100FDS BRASS (6-Hole)	\$104.00
162500	GM-62500	Unibody Spray/Swirl Nozzle Without O-ring 0.040" - G100FDS BRASS (6-Hole)	\$104.00

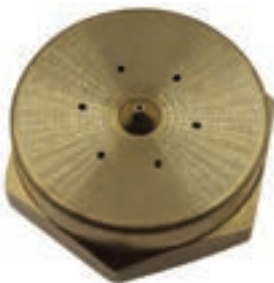

Replacement for Nordson Brass Unibody Spray Wide CF Nozzle (6-Hole)

Nordson Controlled Fiberization (CF) nozzles deliver consistent, accurate adhesive patterns for a wide variety of hot melt adhesive spray applications.

NORDSON	GLENMAR	DESCRIPTION	PRICE
1046126	GM-46126	Unibody Spray/Swirl Wide Nozzle 0.012" - G100FDS Without O-ring (6-Hole)	\$104.00
1046150	GM-46150	Unibody Spray/Swirl Wide Nozzle 0.018" - G100FDS Without O-ring (6-Hole)	\$104.00
1046151	GM-46151	Unibody Spray/Swirl Wide Nozzle 0.020" - G100FDS Without O-ring (6-Hole)	\$104.00
1046152	GM-46152	Unibody Spray/Swirl Wide Nozzle 0.025" - G100FDS Without O-ring (6-Hole)	\$104.00
1046156	GM-46156	Unibody Spray/Swirl Wide Nozzle 0.030" - G100FDS Without O-ring (6-Hole)	\$104.00

NOZZLES



Replacement for Nordson Spray/Swirl Disk Nozzle (6-Hole)

Nordson Controlled Fiberization (CF) nozzles deliver consistent, accurate adhesive patterns for a wide variety of hot melt adhesive spray applications.

NORDSON	GLENMAR	DESCRIPTION	PRICE
860548	GM-60548	Spray/Swirl Disk Nozzle 0.012" - G100FDSBRASS (6-Hole)	\$89.00
860574	GM-60574	Spray/Swirl Disk Nozzle 0.014" - G100FDSBRASS (6-Hole)	\$89.00
860575	GM-60575	Spray/Swirl Disk Nozzle 0.016" - G100FDSBRASS (6-Hole)	\$89.00
860226	GM-60226	Spray/Swirl Disk Nozzle 0.018" - G100FDSBRASS (6-Hole)	\$89.00
860435	GM-60435	Spray/Swirl Disk Nozzle 0.020" - G100FDSBRASS (6-Hole)	\$89.00
100728	GM-00728	Spray/Swirl Disk Nozzle 0.025" - G100FDSBRASS (6-Hole)	\$89.00
810381	GM-10381	Spray/Swirl Disk Nozzle 0.030" - G100FDSBRASS (6-Hole)	\$89.00
810382	GM-10382	Spray/Swirl Disk Nozzle 0.040" - G100FDSBRASS (6-Hole)	\$89.00

NORDSON	GLENMAR	DESCRIPTION	PRICE
860548	GM-60548	Spray/Swirl Disk Nozzle 0.012" - G100FDSSTEEL (6-Hole)	\$118.00
860574	GM-60574	Spray/Swirl Disk Nozzle 0.014" - G100FDSSTEEL (6-Hole)	\$118.00
860575	GM-60575	Spray/Swirl Disk Nozzle 0.016" - G100FDSSTEEL (6-Hole)	\$118.00
860226	GM-60226	Spray/Swirl Disk Nozzle 0.018" - G100FDSSTEEL (6-Hole)	\$118.00
860435	GM-60435	Spray/Swirl Disk Nozzle 0.020" - G100FDSSTEEL (6-Hole)	\$118.00
100728	GM-00728	Spray/Swirl Disk Nozzle 0.025" - G100FDSSTEEL (6-Hole)	\$118.00
810381	GM-10381	Spray/Swirl Disk Nozzle 0.030" - G100FDSSTEEL (6-Hole)	\$118.00
810382	GM-10382	Spray/Swirl Disk Nozzle 0.040" - G100FDSSTEEL (6-Hole)	\$118.00

NOZZLES



Replacement for Nordson Brass Spray Wide Disk CF Nozzle (6-Hole)

Nordson Controlled Fiberization (CF) nozzles deliver consistent, accurate adhesive patterns for a wide variety of hot melt adhesive spray applications.

NORDSON	GLENMAR	DESCRIPTION	PRICE
754666	GM-54666	Spray/Swirl Wide Disk Nozzle 0.012" - G100FDS (6-Hole)	\$89.00
756348	GM-56348	Spray/Swirl Wide Disk Nozzle 0.014" - G100FDS (6-Hole)	\$89.00
753864	GM-53864	Spray/Swirl Wide Disk Nozzle 0.016" - G100FDS (6-Hole)	\$89.00
131340	GM-31340	Spray/Swirl Wide Disk Nozzle 0.018" - G100FDS (6-Hole)	\$89.00
755385	GM-55385	Spray/Swirl Wide Disk Nozzle 0.020" - G100FDS (6-Hole)	\$89.00
125607	GM-25607	Spray/Swirl Wide Disk Nozzle 0.025" - G100FDS (6-Hole)	\$89.00
131998	GM-31998	Spray/Swirl Wide Disk Nozzle 0.030" - G100FDS (6-Hole)	\$89.00
131635	GM-31635	Spray/Swirl Wide Disk Nozzle 0.040" - G100FDS (6-Hole)	\$89.00



NOZZLES



Replacement for Nordson Universal Slot Die Nozzle

Engineered to mount on Universal-series modules, this slot nozzle converts a standard Universal spray station into a precise mini-slot applicator for narrow, edge-clean stripes on hygiene webs, enabling chassis and ear lamination or partial-coverage construction with tighter add-on control and less overspray while preserving the Universal platform's fast changeover and service simplicity.

DESCRIPTION	PRICE
Universal SLOT Die, 25 mm, 0.004" shimplate	\$1,500.00
Universal SLOT Die, 25 mm, 0.012" shimplate	\$1,500.00
Universal SLOT Die, 25 mm, 0.020" shimplate	\$1,500.00
Universal SLOT Die, 50 mm, 0.004" shimplate	\$1,500.00
Universal SLOT Die, 50 mm, 0.012" shimplate	\$1,500.00
Universal SLOT Die, 50 mm, 0.020" shimplate	\$1,500.00
Universal SLOT Die, 75 mm, 0.004" shimplate	\$1,500.00
Universal SLOT Die, 75 mm, 0.012" shimplate	\$1,500.00
Universal SLOT Die, 75 mm, 0.020" shimplate	\$1,500.00
Universal SLOT Die, 100 mm, 0.004" shimplate	\$1,500.00
Universal SLOT Die, 100 mm, 0.012" shimplate	\$1,500.00
Universal SLOT Die, 100 mm, 0.020" shimplate	\$1,500.00

APPLICATORS

HIGH PERFORMANCE - GLENMAR ALTA MAZE APPLICATOR

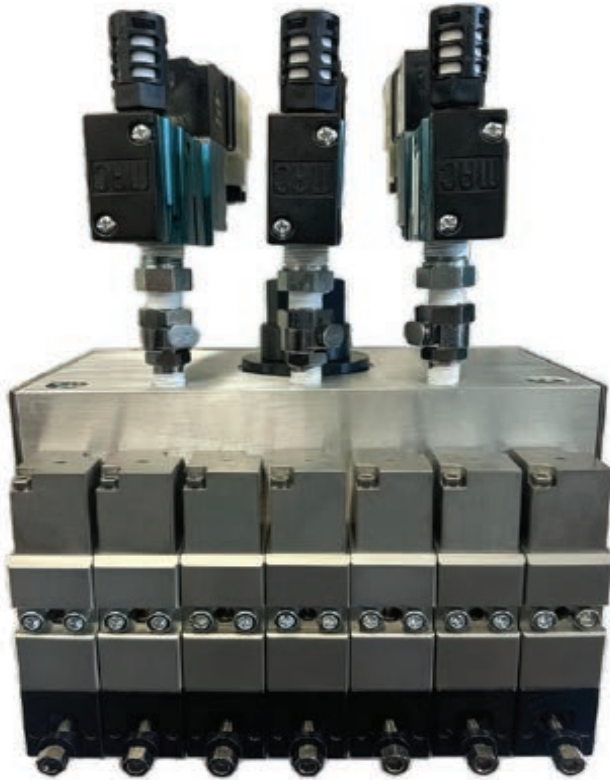

Replacement for Nordson Alta Head applicators

Glenmar's replacement for Nordson Alta applicator heads is a fully compatible and enhanced solution for hot melt spray and slot coating in wide-web applications.

Featuring the same fit and function to the original Alta head it improves upon the design with independent air and hot-melt temperature control for enhanced pattern stability and thermal efficiency.

Supporting up to 96 one-inch hydraulic modules and operation up to 250 °C it works seamlessly with Nordson UM25/UM50 modules, universal nozzles including Melt-Blown, 9/16" UFN hydraulic connections and 24 VDC solenoid valves

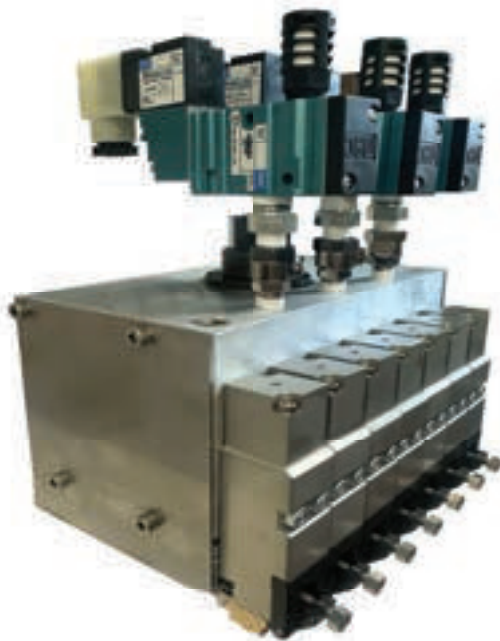

APPLICATORS

HIGH PERFORMANCE - SPEED-COAT SLOT APPLICATOR

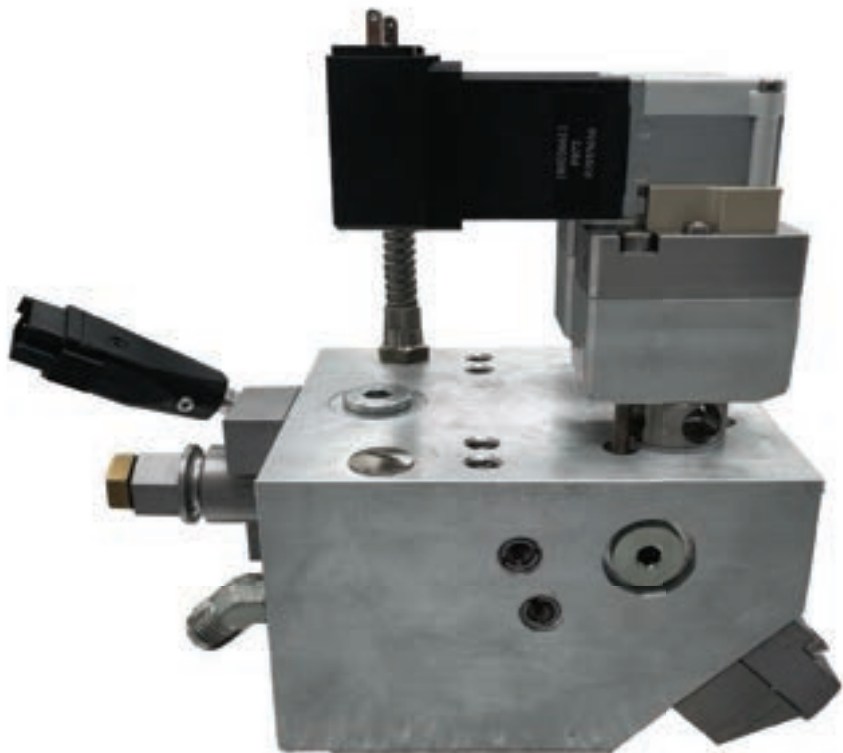

Replacement for Nordson Speed-Coat Slot Applicator

Glenmar's replacement for Nordson Speed-Coat slot applicator head provides fast, uniform adhesive coating for high-speed packaging and converting lines.

Designed for precision and reliability, it ensures consistent adhesive laydown across wide substrates at demanding production speeds.

Fully compatible with existing Speed-Coat systems, this replacement head offers a cost-effective solution without compromising performance.

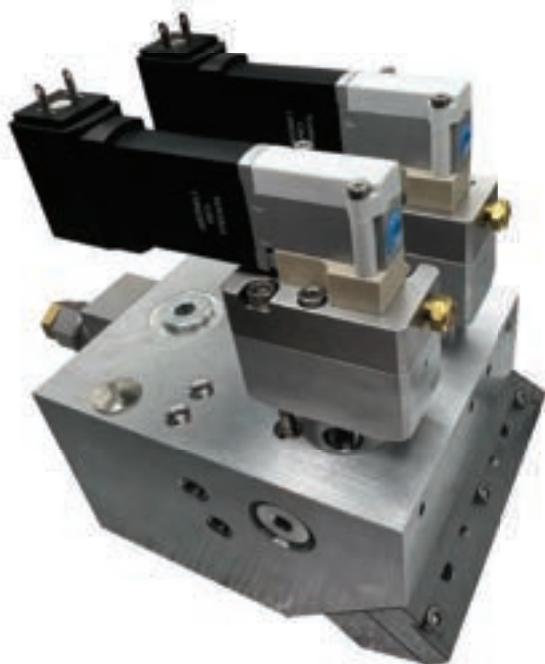

FAST SHIPPING!

+1 908-561-9920

info@glenmartech.com - glenn.kiesel@gmail.com

1233 North Ave, Plainfield, NJ 07062, USA



APPLICATORS

GLENMAR DUAL CORDSET ALTA-MAZE APPLICATORS

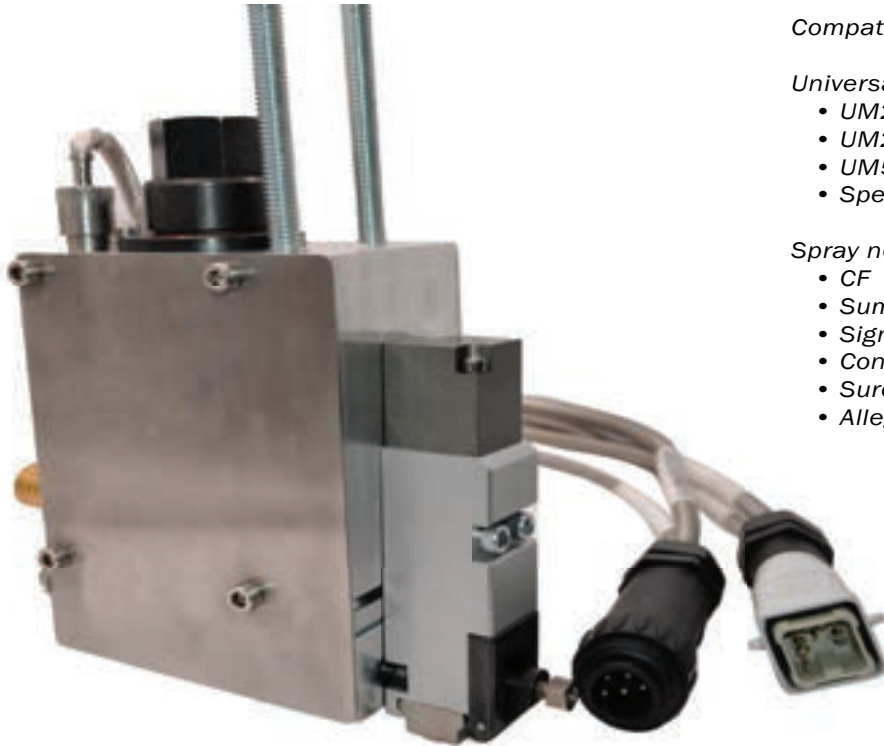

Compatible with

Universal modules:

- UM22
- UM25
- UM50
- SpeedCoat

Spray nozzles:

- CF
- Summit
- Signature
- ControlCoat
- SureWrap
- Allegro



With two bayonet cordsets, this applicator provides independent electrical connections that allow control of two groups of modules separately, enabling dual-pattern capability such as elastic attachment and construction adhesive from a single head. It is designed to exceed Nordson performance at a lower cost, backed by Glenmar's robust manufacturing and support.



APPLICATORS



Replacement for Nordson CF200 Modules & Applicators

Glenmar's G100F (H200F) modules are designed for precise adhesive dispensing. Engineered for industrial environments, this module integrates seamlessly with Nordson ClassicBlue systems.

Glenmar's replacement for the Nordson CF200 spray applicator delivers reliable, fine-pattern hot melt spraying in packaging and nonwoven lines. Its modular design enables precise edge control, reducing overspray while offering rebuildable performance. Fully compatible with twist-on disk or unibody-style CF nozzles, Nordson CF200 pneumatic modules, hoses, filters, and manifold assemblies, it integrates seamlessly into existing systems.

NORDSON	GLENMAR	DESCRIPTION	PRICE
144906	GM-44906	CF200 PAD Swirl Spray Module - G100FPAD	\$330.00
861019	GM-61019	CF200 Swirl Spray Module - G100F	\$330.00
102219	GM-02219	CF200 Swirl Spray Module - G100F	\$330.00
100991	GM-00991	CF201 Applicator (1 Module)	Quote
114411	GM-14411	CF201 Applicator (1 Module)	Quote
152562	GM-52562	CF201 Applicator (1 Module)	Quote
100994	GM-00994	CF202 Applicator (2 Module)	Quote
755951	GM-55951	CF202 Applicator (2 Module)	Quote
124551	GM-24551	CF203 Applicator (3 Module)	Quote
755369	GM-55369	CF203 Applicator (3 Module)	Quote

APPLICATORS

HIGH PERFORMANCE - GLENMAR ALTA MAZE APPLICATOR

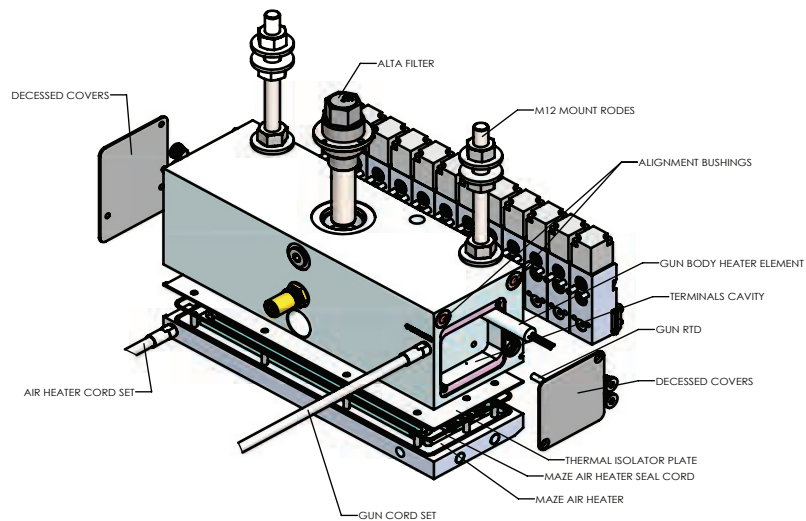
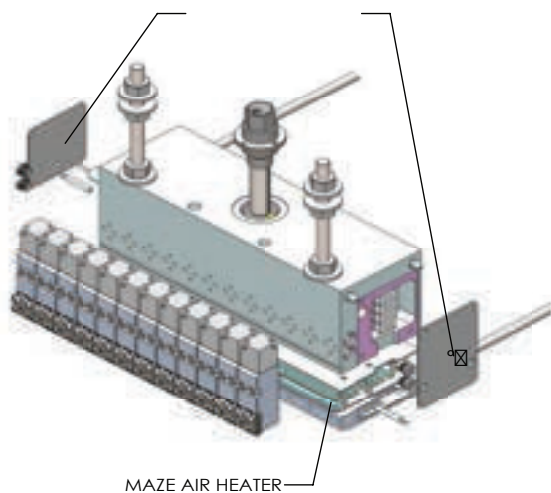

Independent Control of air Temperature

Independent Control of Hot-melt Temperature



- **Voltage:** 240 VCA
- **Sensor:** Ni120 / Pt100
- **Modules:** Um25 / Um50
- **Filter:** 0.006" Alta type (100 mesh)
- **Maximum Temperature:** 250° C / 482° F
- **Hydraulic Connection:** UFN 9/16" (ID. 8mm)
- **Solenoid Valves:** Max, 24VDC

APPLICATORS

HIGH PERFORMANCE - GLENMAR ALTA MAZE APPLICATOR

Use the alignment Pin-Holes in order to make a wide-Web Spray Applicator

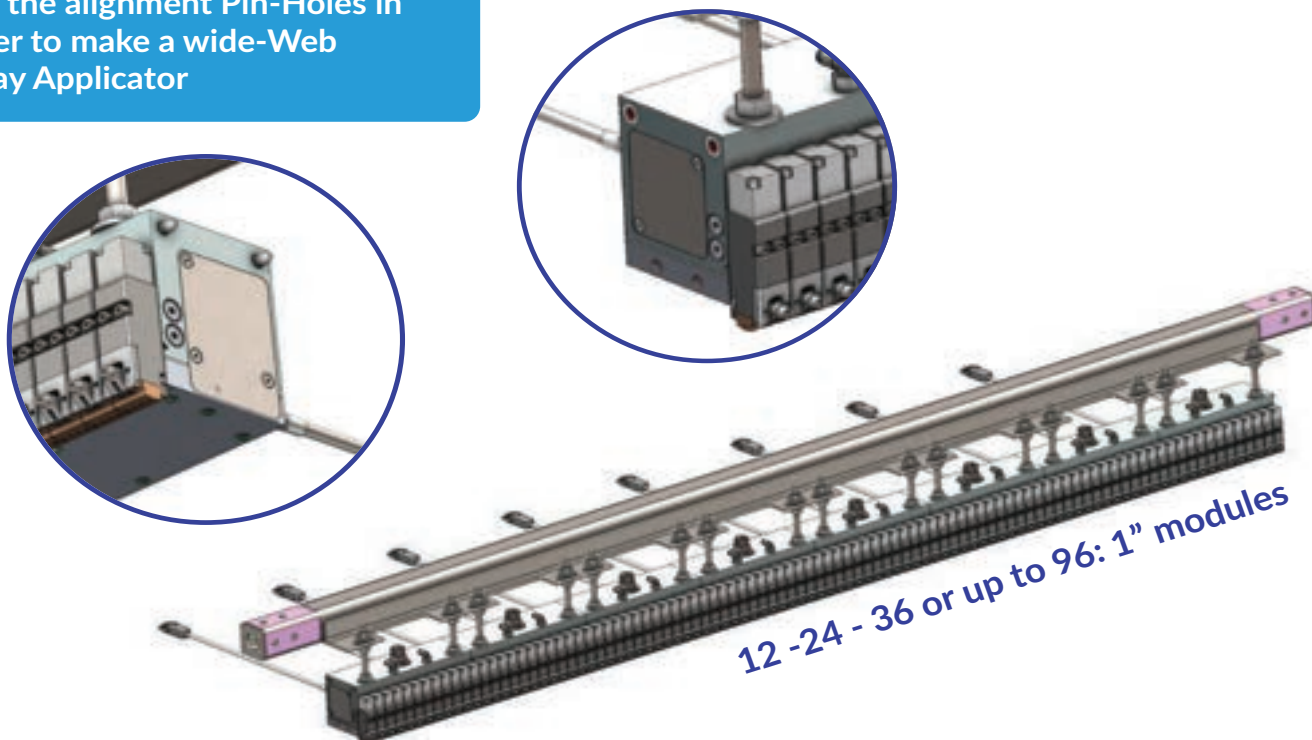

- 12 to 96 1" modules;
- High Performance Spray Applicator with 12 modules Hydraulic Zones;
- Separated Air Maze Control for each Hydraulic Zone;
- Capable of using any Nordson Universal Nozzle (including Melt Blown);
- Capable of using ITW UFD Nozzle.

FAST SHIPPING!

+1 908-561-9920
info@glenmartech.com - glenn.kiesel@gmail.com
1233 North Ave, Plainfield, NJ 07062, USA



HOSES & GEAR PUMPS



Replacement for Nordson High Temperature Hoses

Our replacements for Nordson High temperature hoses are made from high-tech components. They offer exceptional flexibility for both manual hand gun and robotic applications while being reinforced to withstand external and internal structural deformation caused by dynamic movements.

Different lengths available:

NORDSON	GLENMAR	DESCRIPTION	PRICE
1040719	GM-40719	Hot-melt Heated Hose 8.0 m TC 80-08-HT PT100	\$2,465.00
222817	GM-22817	Hot-melt Heated Hose 11.0 m TC-110-13 PT100	\$2,465.00
222818	GM-22818	Hot-melt Heated Hose 12.0 m TC-120-13 PT100	\$2,465.00
222823	GM-22823	Hot-melt Heated Hose 11.0 m TC-110-8 PT100	\$2,465.00



Replacement for Nordson Gear Pump

Our replacements for Nordson gear pumps are widely used in hot melt adhesive systems, providing consistent and precise adhesive flow for demanding industrial applications. Engineered for high reliability, they deliver metered flow rates even under intense pressure and elevated temperatures. These pumps are fully compatible with Nordson® MX, PR, and VersaBlue® series melters.

NORDSON	GLENMAR	DESCRIPTION	PRICE
7109715	GM-09715	Gear pump SN0030 (0.30 cc/rev)	\$1,735.00
259598	GM-59598	Gear pump SN0030 (0.30 cc/rev)	\$1,735.00
729105	GM-29105	Gear pump SN0046 (0.46 cc/rev)	\$1,735.00
254406	GM-54406	Gear pump SN0046 (0.46 cc/rev)	\$1,735.00

SPARE PARTS

Need spare parts for **Nordson** or **ITW Dynatec** hot melt systems?
Glenmar Technology provides high-quality replacement parts at a fraction of the
OEM Price

Contact us for more details!
+1 (908) 561-9920 --- info@glenmartech.com

\$90.00



Replacement for ITW Dynatec
Filter Head

\$145.00



Replacement for Nordson
Filter for AltaSpray Applicators

\$65.00



Replacement for ITW Dynatec
Tank Filter

\$75.00



Replacement for Nordson
Speedcoat II - Cylinder Cover 7162021

\$85.00



Replacement for Nordson
Speedcoat II - Double Threaded Body

\$75.00



Replacement for Nordson
Speedcoat II - Cylinder Cover 7173123

\$75.00



Replacement for Nordson
Speedcoat II - Aluminum Body

\$95.00



Replacement for Nordson
Speedcoat II - Block Adaptor Gun

\$175.00



Replacement for Nordson
UM50 Body

REBUILD KITS

Glenmar technology service kits provide all the essential components needed to rebuild and restore your UM22®, UM25®, and UM50® modules. The minor kit (1049909) includes critical wear parts such as the fully assembled cartridge for routine maintenance, while the major kit (1049908) adds components like the needle-and-piston assembly and compression spring for a full overhaul.

Replacement for Nordson UM22, UM25, and UM50 Minor Service Kit PN#1049909



Replacement for Nordson UM22, UM25, and UM50 Major Service Kit PN#1049908



NORDSON	GLENMAR	DESCRIPTION	PRICE
1049909	GM-49909	UM22, UM25, and UM50 Minor Service Kit	\$70.00
1049908	GM-49908	UM22, UM25, and UM50 Major Service Kit	\$90.00

REBUILD KITS

Glenmar Technology service kits include high-wear parts such as original Turcon® Variseals, pistons, gaskets, and other critical components to help maintain sharp adhesive cutoff, consistent flow, and reliable performance in high-speed nonwoven applications.

Replacement for Nordson Speed-Coat Minor Service Kit PN#7173117 Kit-SVC SC orifice sealings



Replacement for Nordson Speed-Coat Major Service Kit PN#7173115 Kit-SVC SC orifice Rebuild

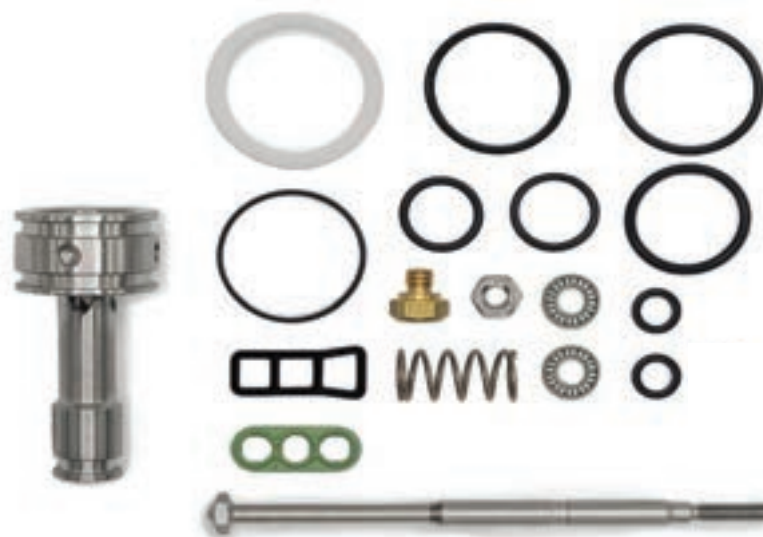

NORDSON	GLENMAR	DESCRIPTION	PRICE
7173117	GM-73117	Speed-Coat Minor Service Kit	\$225.00
7173115	GM-73115	Speed-Coat Major Service Kit	\$390.00

MODULES

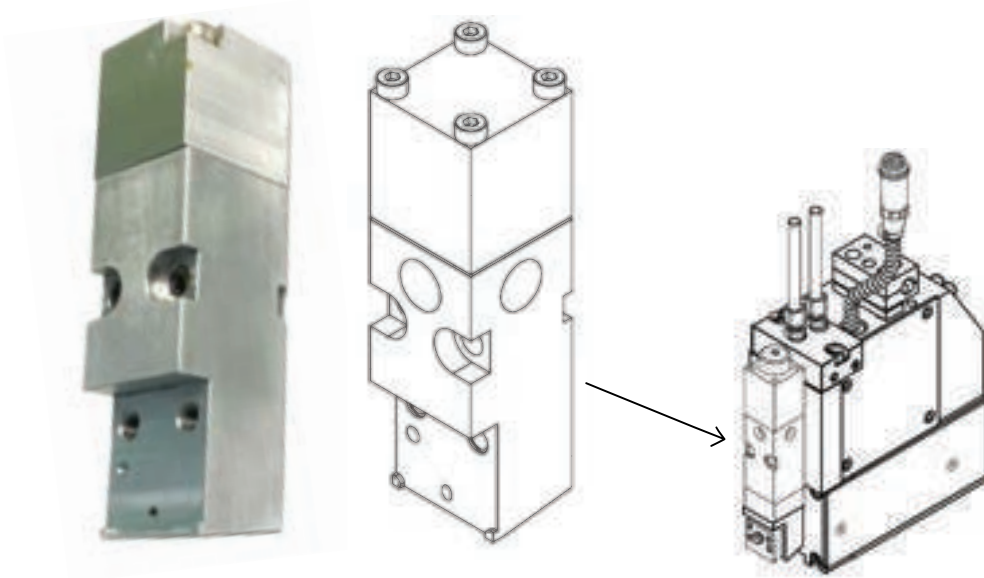

Compatible Rebuilds for ITW Dynatec UFD Spray

High-quality replacement for ITW Dynatec UFD Spray Applicator.

ITW	GLENMAR	DESCRIPTION	PRICE
113778	GM-13778	UFD Spray Module, High Speed - Vertical	\$900.00
110840	GM-10840	UFD Spray Module, High Speed - Horizontal	\$900.00

NOZZLE ADAPTER

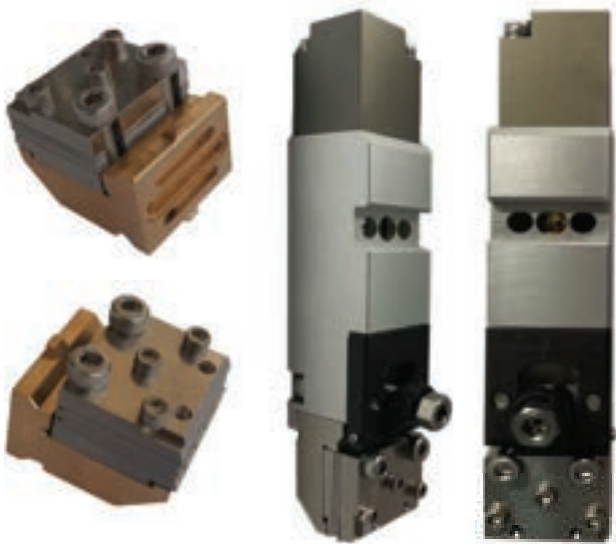

Adapter: Nordson Universal Modules - ITW UFD nozzles

This adapter changes Replacement for Nordson modules to accept ITW Dynatec UFD HS nozzles.

Works with Replacement for Nordson Universal Modules:

UM25
UM50

\$250.00

NOZZLES

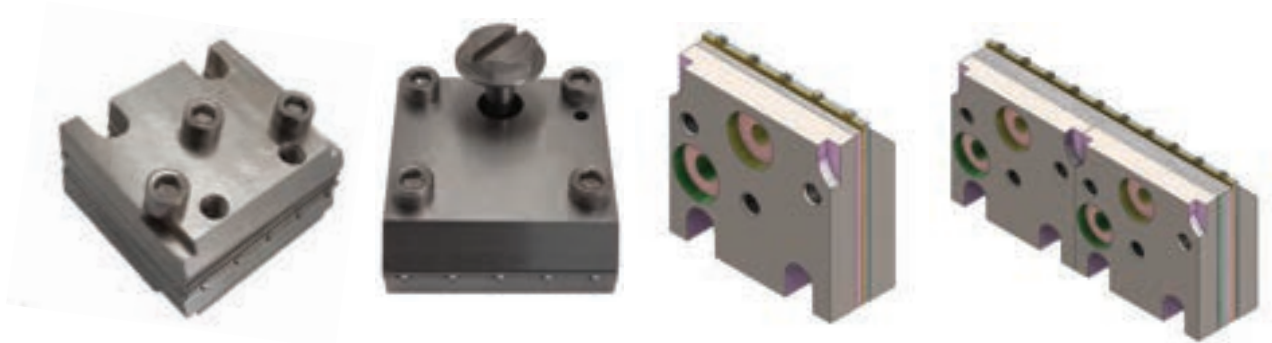









Compatible Rebuilds for ITW Dynatec UFD Random Fiber Nozzles

Our replacements for ITW Dynatec UFD Random Fiber Nozzles are designed for high-speed hot melt applications. Featuring Laminated Plate Technology and durable stainless steel construction, they are ideal for nonwoven and packaging applications.



















ITW	GLENMAR	DESCRIPTION	PRICE
112824	GM-12824	UFD High Speed Random Fiber Nozzle	\$500.00
112654	GM-12654	UFD High Speed Random Fiber Nozzle	\$850.00
120845	GM-20845	UFD Random Fiber Nozzle	\$500.00

Contact us to explore custom nozzle configurations.
We'll work closely with you to design the optimal laminated plate setup for your application.

<p>IT 845 L 016 - 1H</p>  <p>↑</p>	<p>IT 845 L 016 - 2H</p>  <p>↑↑</p>	<p>IT 845 L 016 - 3H</p>  <p>↑↑↑</p>	<p>IT 845 L 016 - 4H</p>  <p>↑↑↑↑</p>	<p>IT 845 016 - 5H</p>  <p>↑↑↑↑↑</p>
<p>IT 845 R 016 - 1H</p>  <p>↑</p>	<p>IT 845 R 016 - 2H</p>  <p>↑↑</p>	<p>IT 845 R 016 - 3H</p>  <p>↑↑↑</p>	<p>IT 845 R 016 - 4H</p>  <p>↑↑↑↑</p>	

NOZZLES

Compatible Rebuilds for ITW Dynatec UFD High Speed Random Fiber Nozzles

Ø 0.016		Ø 0.020	
<p>IT 845 L 016 - 1H</p>  <p>↑</p>	<p>IT 845 R 016 - 1H</p>  <p>↑</p>	<p>IT 918 L 020 - 1H</p>  <p>↑</p>	<p>IT 918 R 020 - 1H</p>  <p>↑</p>
<p>IT 845 L 016 - 2H</p>  <p>↑↑</p>	<p>IT 845 R 016 - 2H</p>  <p>↑↑</p>	<p>IT 918 L 020 - 2H</p>  <p>↑↑</p>	<p>IT 918 R 020 - 2H</p>  <p>↑↑</p>
<p>IT 845 L 016 - 3H</p>  <p>↑↑↑</p>	<p>IT 845 R 016 - 3H</p>  <p>↑↑↑</p>	<p>IT 918 L 020 - 3H</p>  <p>↑↑↑</p>	<p>IT 918 R 020 - 3H</p>  <p>↑↑↑</p>
<p>IT 845 L 016 - 4H</p>  <p>↑↑↑↑</p>	<p>IT 845 R 016 - 4H</p>  <p>↑↑↑↑</p>	<p>IT 918 L 020 - 4H</p>  <p>↑↑↑↑</p>	<p>IT 918 R 020 - 4H</p>  <p>↑↑↑↑</p>
<p>IT 845 016 - 5H</p>  <p>↑↑↑↑↑</p>		<p>IT 845 020 - 5H</p>  <p>↑↑↑↑↑</p>	

APPLICATORS

GW-ALT head 12" compatible with Nordson Universal Modules + ITW UFD nozzles

GW-ALTA Head 12" is an innovative hybrid applicator that merges the robustness of Nordson Universal modules with the precision spray technology of ITW DYNATEC UFD (Uniform Fiber Deposition) nozzles. This custom-engineered solution offers converters a high-performance alternative for wide web nonwoven applications, especially in hygiene production lines.

Designed for compatibility and flexibility, the GW-ALTA head allows manufacturers already using Nordson platforms to upgrade to UFD-level spray performance without overhauling their entire system.

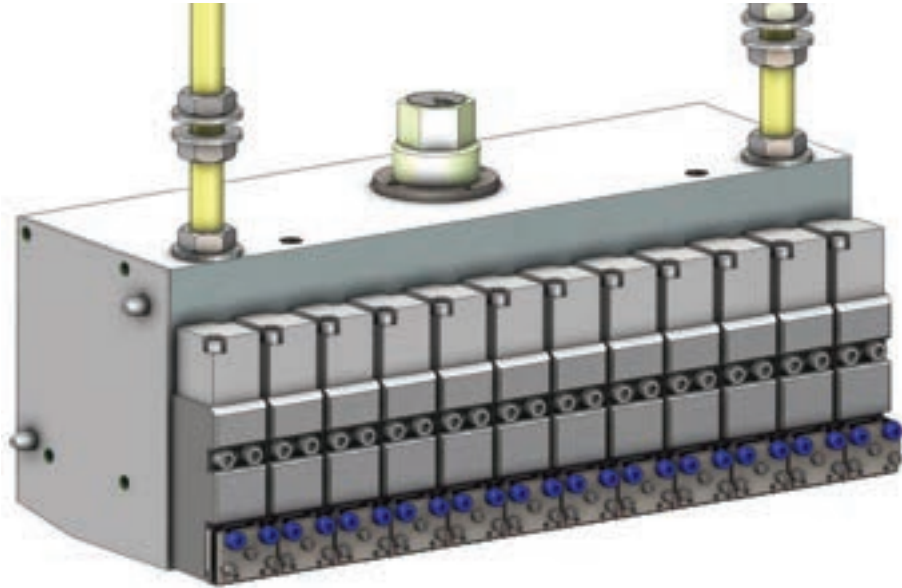

Glenmar's Replacement Hybrid for Nordson UM Module compatible with ITW Dynatec UFD HS Nozzles



Glenmar's Replacement for ITW Dynatec UFD HS Nozzles

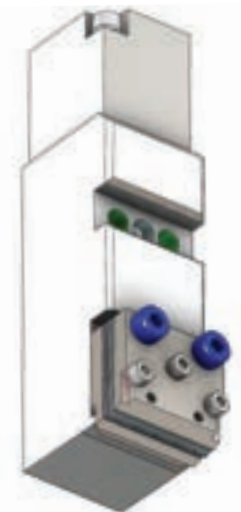

THE BEST OF BOTH WORLDS

**NORDSON - INSIDE
ITW DYNATEC - OUTSIDE**

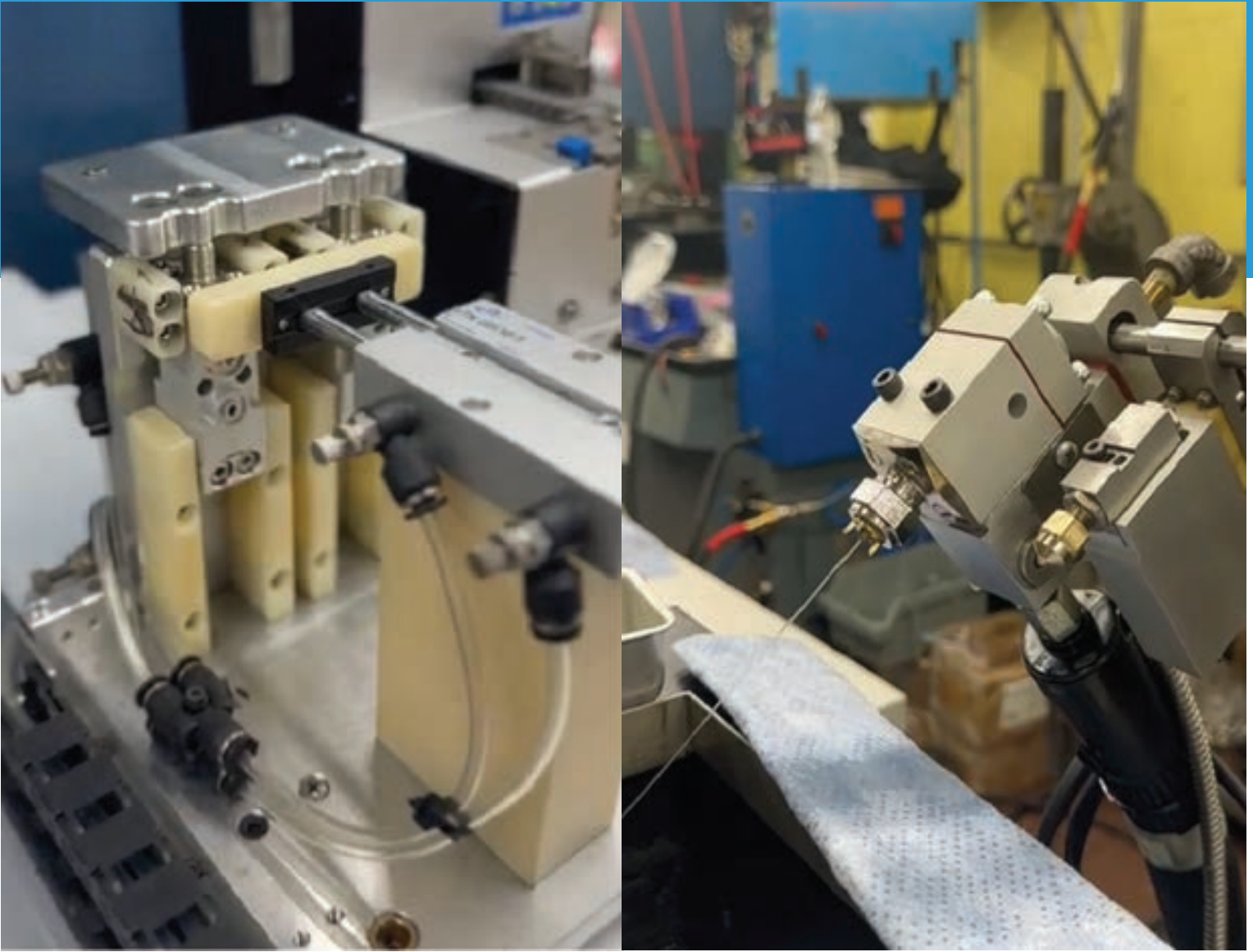

Thank You for Choosing Glenmar Technology

Glenmar Technology is a trusted global manufacturer of high-quality, cost-effective replacement parts for Nordson and ITW Dynatec hot melt adhesive systems. From our facility in New Jersey, USA, we use advanced manufacturing processes to produce modules, nozzles, applicators, and glue guns that meet or exceed OEM standards, at a significantly lower cost.

With more than 20 years of experience serving customers across North America, Latin America, Europe, Africa and Asia, Glenmar has become a reliable partner for companies looking to reduce operational costs without compromising performance or uptime. Our solutions are engineered for precision, repeatability, and long-term reliability across a wide range of industrial applications.

We offer worldwide shipping and flexible payment options including credit card, PayPal, and wire transfer. For more information, product cross-references, or to place an order, visit our website and enter the OEM part number in the search bar.

